

EH102 - A03
AMRFEO PRIVATE LIMITED

Address: 32A, Chittaranjan Avenue, Calcutta
700012, India

Tel: +91 33 40072855

Email: yavi@amrfeo.com;

amrfeo@gmail.com

Web: www.amrfeo.com



Main Product: Bentonite; Polymer, Additives
& Foaming agent for Civil Engineering
application



Amrfeo Pvt Ltd is the leading producer of bentonite for wide range of application. We also produce PHPA, Drilling Foam and other supporting additives for drilling.

展商名录 (按公司名称字母排序)

Exhibitors List by Alphabetical Order

EH102 - B04

Pine-Pacific Corporation Limited

Add:150 Moo 6,Bang Bo,Samut Prakan
10560 Thailand

Email:it@pinepacific.com

Tel:027055900; +6627055900

Web:<https://www.pinepacific.com/>

Main Product:Foundry Equipment and raw
materials

The company focuses on delivering a wide range of engineering solutions, including products like Induction Furnaces and specialized maintenance services. It also provides technical materials such as Special Alloys and essential commodities like Ferro Alloys, supporting various industries with the necessary tools for efficient production and specialized applications.



EH102 - A10
SANXIA KITCHENWARE TECHNOLOGY
(THAILAND) CO.,LTD.

Add:6 Moo 10, Khao Khan Song Subdistrict,
Sri Racha District, Chonburi Province 20110
Email:ironwill_zhao@cncookware.com
Tel:0066-937549522
Web:www.cncookware.com

Main Product:enamel cast iron kitchenware

Founded in 1998, Hebei Sanxia Kitchenware Technology Co. LTD (former name: Xingtai Sanxia Cast Iron Co. LTD) is a high-tech enterprise who specializes in Designing, R&D, Production and Sales of Cast Iron, Enamel Cast Iron, Stainless Steel, Carbon Steel and Aluminum Kitchenware. Sanxia has built a mass of first-class production equipment by import and own independent research and development, and also created national certified CNAS laboratory, which are important groundworks for production innovation and development, and essential driving forces for leading kitchenware industry to progress persistently domestic and overseas. And, Sanxia' export volume has ranked first in national industry of enamel cast iron for many years, and enjoys a good reputation, credibility and reputation in the kitchenware market.

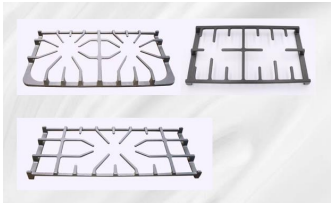

展商名录 (按公司名称字母排序)

Exhibitors List by Alphabetical Order

EH102 - B05

SIAM LK CO., LTD.

Ningbo LK Technology Co., Ltd.

LK NINGBO MACHINERY(Malaysia) SDN BHD

LK ジャパン株式会社



Add:99/10 Moo2, T.Bankao, A.Panthong,
Chonburi 20160 Thailand

Tel: +66 3845 4809

Email: trista.yu@lk.world

Web: www.lk.world



Main Product:DCM、IMM、CNC MACHINING
CENTER、 ROBOT AUTOMATION



LK Technology Group Limited was founded in 1979 in Hong Kong (referred to as LK Technology, stock code [HK0558]). As an absolute leading company in the die casting machine field, our market share exceeds 50% in long term. The company actively expands its international business with 15 production bases and over 60 service centers worldwide. LK has long been at the forefront of setting industrial standards and undertaking national research projects, continuously leading the development of die casting technology. We has pioneered the technology of integrated giga die casting and successively created the world's first 6000T, 9000T, 12000T, and 16000T giga intelligent die casting units. Currently, the world's three 10000-ton die casting machines all come from LK Group.



EH102 - C45
SWELL WELL MINECHEM PVT.LTD

Add:urvey no. 187, Village – Dhunai, Bhuj –
Mandvi Road, Opp: Lodaya Farm (Vinod
Baug) Mandvi. Kutch. Gujarat. INDIA.

Email:bentonite@swellwell.com

exports@swellwell.com

Tel:+91 9712950165

Web:www.swellwell.com

Main Product:Micro Tunnling;Iron Ore
Palletization

The “Swell Well Minechem Pvt. Ltd” is a well-established company in India in the field of mineral mining industry, Swellwell Minechem has been credited with ISO-9001:2015 certification. We have fully integrated bentonite processing plant, strict quality control and state of art dispatch facility. Mining for Bentonite in terms of quality and social benefit. Our corporate office situated at Bhuj, Gujarat, India.



展商名录 (按公司名称字母排序)

Exhibitors List by Alphabetical Order

EH102 - C34

Thai Automation and Robotics Association



Add:Safflewood Building, 868 Phetkasem Road, Bang Kasem Road, North Bangkok 10160

Tel:062-1924646

Web:<https://thaitara.org/en/>

Email:info@thaitara.org

TARA stands for Thai Automation&Robotics Association. The alliance brings together Thai system integrators (SI) who are well-versed in automation and robotics. Our common goal is to make automation and robotics a key factor in developing and increasing productivity. The association works in various industries and its main goal is to help drive the Thai economy towards Industry 4.0.

EH102 - C26

Thai Subcontracting Promotion Association

Add:86/6 Bureau of Supporting Industrial
Development(MIDI)Building Soi Trimit.Rama
4 Rd.Klongtoey.Bangkok 10110

Tel:(+66)85-5695536 ; (+66)95-2673895

Email:piyachat.s@thaisubcon.com;

worakarn.s@thaisubcon.com

Web : <https://thaisubcon.com/en/>



Thai Subcon has more than 400 company members. has a vision and commitment to bring about all members' capacities in connecting and enhancing the potential of business in various fields including production, management, marketing, purchasing, and information at international standards.

展商名录 (按公司名称字母排序)

Exhibitors List by Alphabetical Order

EH102 - A23

ABP INDUCTION SYSTEMS (SHANGHAI) CO., LTD

Add:No.118,Lane 289 Fulian II Rd., Baoshan District Shanghai, China 201906

Email:nick.huang@abpinduction.com

Web:www.abpinduction.com

Tel:+86-21-56391278

Fax:+86-21-33854218

Main Product:Medium-frequency induction melting system, medium-frequency induction holding system, pouring system, medium-frequency induction heating system, etc.

ABP induction systems (Shanghai) Co., LTD., as the wholly owned subsidiary of ABP induction systems group in China, has been dedicated to serving the casting, forging and steel industries, providing customers with complete solutions for the melting, pouring and heating systems of ferrous and non-ferrous metals.

With a history of more than 120 years, ABP Group is headquartered in Dortmund, Germany, with branches and offices in 16 countries around the world, focusing on ten major industrial regions in the world: Germany, Sweden, Russia,US, Mexico, Brazil, China, India, Thailand and Japan.

ABP PEOPLE.
INDUCTION TECHNOLOGY.
SUCCESS.

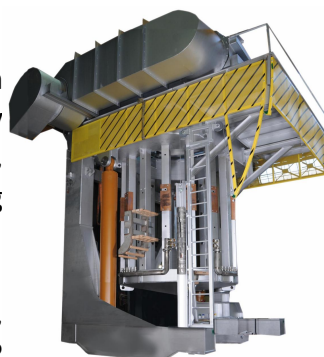

EH102 - B30
BAOTOU CASTING FRIEND INDUSTRIAL
MATERIALS CO.,LTD.

Add:8-B1414, Tianfu Business Square, No. 1,
Jianhua South Road, Jiuyuan District, Baotou
city, Inner Mongolia
Email:zhuyougy@163.com
Web:www.hmfcyl.com
Tel:+86-472-7909880

Main Product:Casting seacoal

Baotou casting friend industrial materials co.,LTD is a professional manufacturer of "Cao yuan lang" coal dust and the α starch. The company owns two of the most advanced automatic production lines in China with the coal dust annual capacity of 100,000 tons and α starch annual capacity of 10,000 tons. Moreover, the company adheres to the professional production, technology research and development, after-sales tracking service concept to gains a good reputation in the industry.



展商名录 (按公司名称字母排序)

Exhibitors List by Alphabetical Order

EH102 - C17

**RUIGUANG GENERAL TECHNOLOGY CO.,
LTD.**

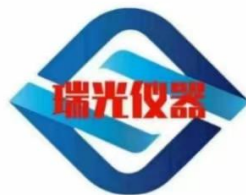

Add:45 Jiagezhuang West Road,
Wangxinzhuang Town, Pinggu District,
Beijing

Email:361288656@qq.com

Tel:15301158087

Main Product:icp-aes

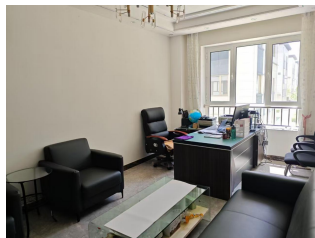

Beijing Ruiguang General Technology Co., Ltd. is a modern enterprise, located in Pinggu District, the company is deeply rooted in China's machinery, instrument industry more than 20 years of development of fertile soil, is the new technology enterprises in Beijing. The company sets research and development, manufacturing, sales and service in one, has a perfect management system. The company's main products are plasma emission optical harmonics and other analytical instruments, with many years of spectral analysis instruments research and development and manufacturing history, is a well-known manufacturer of spectral analysis instruments in China.

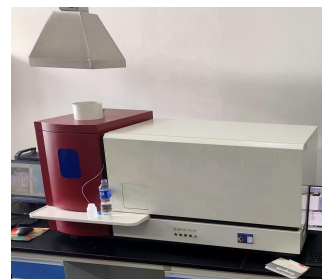

EH102 - C10
3D PRINTING TECHNOLOGY, INC.

Add:No. 7 Jinyi Street, Gaoliying Town,
Shunyi District, Beijing, Chengtong
Electronics

Email:rp@lyafs.com.cn

Web:www.3dptek.com

Tel:+86-10-62117806

Main Product:3D printing intelligent
equipment, 3D printing rapid casting, 3D
printing raw materials/binders

3D Printing Technology, Inc.is a provider of 3D printing equipment and rapid manufacturing services, recognized as a National High-Tech Enterprise, a "Specialized and New" Enterprise, and a Typical Application Scenario Supplier for Additive Manufacturing by the Ministry of Industry and Information Technology. The company specializes in laser and binder jetting 3D printing equipment, material technologies, and application processes. Its business scope includes the research and production of 3D printing equipment and raw materials, rapid manufacturing services for metal finished parts, and technical support services for 3D printing processes. Sandi Technology has established a comprehensive 3D printing rapid manufacturing industrial chain, with applications spanning across the maritime, aerospace, automotive, energy and power, industrial machinery, 3C electronics, and rehabilitation medical sectors.

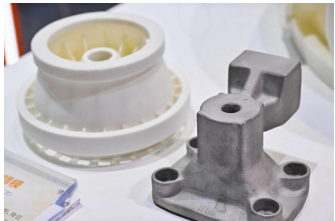
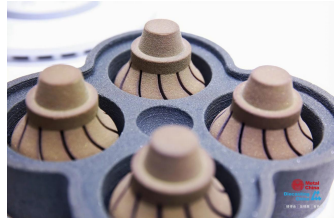

展商名录 (按公司名称字母排序)

Exhibitors List by Alphabetical Order

EH102 - B33

BEIJING TINDER LOST FOAM CASTING TECHNOLOGY CO.,LTD.

Add:4-001, building2,7 Yunshan Road,Tongzhou District,Beijing,China

Email:tinder@lost-foam.com.cn

Web:www.lost-foam.com.cn

Tel:+86-10-61503945

Fax:+86-10-61503945-624

Main Product:The whole set of lost foam process equipment、Stand-alone equipment, and all kinds of high alloy steel

TINDER is a lost foam casting high-tech enterprise, can provide project design, the whole set of lost foam process equipment, technology service castings and international trade; TINDER has been awarded ISO9001-2008 Quality Management System certification. TINDER's equipment and casting are exported to America, France, England, Germany, Austria, Netherland, Italy, Ethiopia, Russia, Canada, Ukraine, India, Japan, Korea, Burma and etc., praised by customers.



EH102 - C42

BEIJING SINGU KELLER AUTOMOTIVE COLD FORMING PARTS INC.



Add:No.12,Huankezhong Rd,Zhongguancun Science Park Jinqiao Science Industrial Park, Tongzhou District,Beijing, China

Email:sy@singukeller.com

Web:http://www.singukeller.com

Tel:010-60506892/13366379585



Main Product:In the production of black metal manufacturing cold von berg systeme (including standard, non-standard and other related products); Cold von berg systeme technical consulting and services; Sales produced products. Import and export business (excluding distribution business).



Beijing Singu Keller Automotive Cold Forming Parts Inc. was founded in 2004, is a Sino-German joint-stock company. Singu Keller is professional in designing and manufacturing automotive cold forming parts.The company has the title of national high-tech enterprises, high-tech enterprises in Zhongguancun,TOP100 high-growth enterprises in Zhongguancun, and the title of Beijing patent demonstration enterprises, it is a R & D institution of Enterprise in Beijing.Singu Keller combines with theChinese market, inherits and develops A & E KELLER company'sstrong technical strengthand a hundred years of experience, uses the most advanced 6-stationscold forming equipment fromGermany.

展商名录 (按公司名称字母排序)

Exhibitors List by Alphabetical Order

EH102 - B16

**CANG ZHOU SHUN FA GRINDING WHEEL
MANUFACTURE CO.,LTD.**

Add:No.1 Shunfa Road,Economic and Technological Development Zone,Machang Town,Qingxian county,Cangzhou city,Hebei province

Email:shunfashalun@163.com

Web:www.shunfashalun.com

Tel:+86-317-4071101

Main Product:Polywer Composite Grinding Wheel \ Carbon Alloy Grinding Wheel

CANGZHOU SHUNFA GRINDING WHEEL Manufacturing Co. , Ltd. , founded in 1986, is the first group (2003) awarded by the General Administration of Quality Supervision, Inspection and Quarantine of the "national industrial production license" of the company. Since the establishment of the factory 35 years ago, Shunfa grinding wheel in line with the "quality and efficiency, scientific research and development, " the idea of running the factory, and constantly forge ahead. From the original ordinary grinding wheel to 2008 developed polymer composite grinding wheel, and then to 2020 introduced carbon alloy grinding wheel. In more than ten years, the products are constantly updated, so that the scientific and technological content of products gradually increased. Shunfa allows more foundry enterprises to really use the safe, efficient, low consumption, green grinding wheel.



EH102 - B22
CHANGSHU SHPC & MECHANICAL CO., LTD.

Add: Dongzhang Industrial area, BiXi town, Changshu city, Jiangu, China
Email: shaunh519@china-evergreat.com
Web: www.china-shpc.com
Tel: 0512-52275081
Fax: 0512-51531121

Main Product: Automotive & Warranty parts; Door locks and windows' accessories; Medical equipment parts; Textile machinery parts; Agricultural machinery parts Etc.

CHANGSHU SHPC & MECHANICAL CO., LTD. , whose predecessor was CHANGSHU LOST WAX CASTING FACTORY, founded in 1975, is a specialized manufacturer by use of lost wax casting process technology on the production of precision casting parts in CHANGSHU city , Jiangu Province of China . Our companies have an excellent management team , independent capacity of products development, and efficient management system, and have passed international quality certification system ISO9001:2015, also environmental management certification system of ISO14001:2015, and Automotive industry quality certification system IATF16949:2016. Main products consist of building hardware for door locks and windows , Automotive and warranty parts , Textile machinery parts , Agricultural machinery parts, Medical equipment accessories and soon on . and various materials of precision castings products include such as carbon steel, low alloy steel, stainless steel, gray iron, ductile iron, brass alloy , aluminum alloy etc.



CHANGSHU SHPC



Automotive transmission parts



Automobile exhaust emission accessories

展商名录 (按公司名称字母排序)

Exhibitors List by Alphabetical Order

EH102 - A16

**CHANGZHOU JIESEN INTELLIGENT
ENVIRONMENT EQUIPMENT CO., LTD.**

CJCS®

Add:No. 6, ziyah Road, Xinqiao town,
Xinbei District, Changzhou city

Email:lslu@ls-filter.com

Web:www.czjiesen.com

Tel:+86-519-81887180

Main Product:JYC series flat bag dust collector, JODF series inclined cartridge dust collector, JGQ series high negative pressure vacuum cleaning system, JTTF series activated carbon adsorption desorption catalytic purification device, JYTC series compressed air reverse blowing + mobile ash car type side inserted flat bag dust collector

Changzhou Jason Intelligent Environment Equipment Co., Ltd. implements a strict ISO9001 quality certification system to ensure that Jason has a stable and high-quality filter equipment in China and its customers and agents in more than 20 countries around the world, and assumes global responsibility for safety, health and the environment (S.H.E.). In addition, Jason's environmental partners, distributed in China and all over the world, have experienced professional training and are ready to solve all the problems that customers meet in the process of production. Jason people firmly believe that the filter products that coagulate all the wisdom of Jason will make a contribution to the blue sky and clear water of all mankind.



EH102 - C17
CHANGZHOU PENGBAO NEW MATERIALS
CO., LTD.

Add:No. 12, Building 77-10, Huaide South Road, Zhonglou District, Changzhou City
Email:wjr@czpengbao.com
Web:<http://www.czpengbao.com/about.html>
Tel:86+13906121508

Main Product:Nodulizer 、 Inoculant 、 Spheroidized core wire、 Fertility core wire、 Casting Pipe Mold Powder、 Silicon Carbide

Changzhou Pengbao New Materials Co., Ltd. has been committed to the production and research and development of high-quality spheroidizing agents and inoculants. We have accumulated rich experience in the development, application, and production management of spheroidizing agents and inoculants. Our company is dedicated to the research and promotion of wire feeding spheroidizing inoculation technology, providing one-stop services from the design and construction of spheroidizing stations to the production and application of alloy lines, and providing support and assistance for the upgrading of metallurgical equipment and metallurgical technology for many domestic casting enterprises.



P E N G B A O

鵬寶



展商名录 (按公司名称字母排序)

Exhibitors List by Alphabetical Order

EH102 - C09

**CHANGZHOU THINKS ENVIRONMENTAL
TECHNOLOGY CO.,LTD.**

Add:No.3 Wangxian Road. Airport Industrial
Park,xinbei District,Changzhou China

Email:taogang@thinksenvironment.com

Tel:+86-519-81190231

Fax:+86-519-83269236

Main Product:TF/TP/TD

Changzhou Thinks Environmental
Technology Co., Ltd. is a system supplier
focusing on industrial air pollution control,
relying on self-developed high-quality
products, to provide customers with their
own core technology solutions.We have
global service capabilities, including power
plant incinerators, foundries, non-ferrous
metals industry, cement/lime/gypsum
industry, gravel and asphalt industry and
chemical industry.

Thinks®

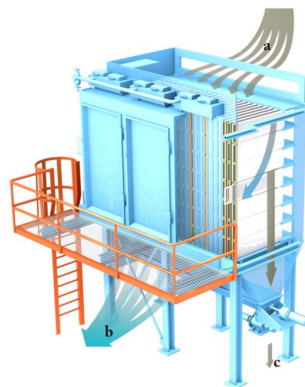
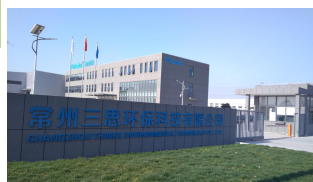

EH102 - C01

Changzhou Changjiang Casting Material Co., Ltd.



Add: No. 88 Xinchang Road, Xinzha Town,
Zhonglou District, Changzhou, Jiangsu
Tel:086-0519-68880169
Email:114076754@qq.com



Main Product:coated sand; reclaimed sand

Changzhou Changjiang Foundry Materials Co., Ltd. was established in 1991. Currently, the company has 96 employees and is a high-tech enterprise specializing in the production of casting materials, including coating sand, regenerated sand, and casting sand cores, as well as their sales and services. The company operates three production lines with an annual capacity of 150,000 tons of coating sand, and two regeneration lines with an annual handling capacity of 60,000 tons of casting waste sand. It also has over 40 cold and hot core shooters. Our company is recognized as a high-tech enterprise and has been awarded the title of “Casting Waste/Old Sand Regeneration Demonstration Enterprise” by the Jiangsu Casting Association. It also holds the Ministry of Industry and Information Technology’s qualification as a “Casting Waste Comprehensive Utilization” demonstration base and has 15 authorized utility patents.



展商名录 (按公司名称字母排序)

Exhibitors List by Alphabetical Order

EH102 - B18

FOSHAN YOSHIDA NEW MATERIALS TECHNOLOGY CO., LTD.

Add:Room 329, Floor 3, Xiayi Dongbiwei Industrial Zone, Guicheng, Nanhai District, Foshan, Guangdong, China

Email:fsyoshida@aliyun.com

Web:www.gdyoshida.com

Tel:+86-757-85685335

Main Product:carbon raiser, graphited petroleum coke, calcined petroleum coke and other carbon related products

Foshan yoshida new materials technology co., LTD.was established in November 2012, we have been an integrated company specialized in researching production and marketing carbon related products.We own strong technology,advanced production equipments and distinguished experts and professors as a technical consultant for comprehensive research and development.

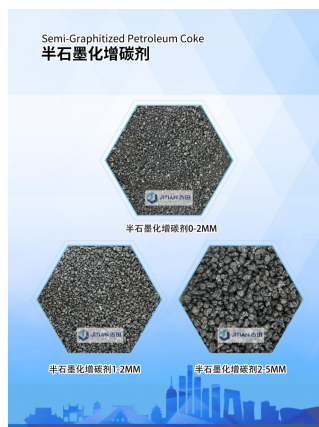
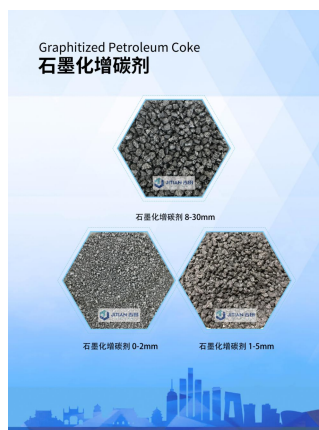
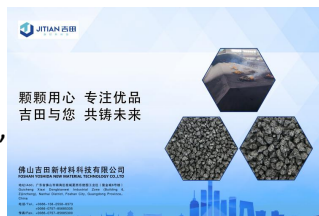

EH102 - A21
FOSHAN IKAT PRECISION DIAMOND TOOLS CO., LTD

Add:No. 102, Building 15, Phase 1, Liandong Yougu, Jianshadong Third District, Danzao Town, Nanhai District, Foshan City, Guangdong Province
Email:zhanghui@ekort-tool.com
Tel:13827789960

Main Product:PCD non-standard reamers, boring cutters, cemented carbide non-standard tools, deep space drills, HSK-BT shank series indexable CNC tools

Chinese Introduction: Foshan Ekart Precision Diamond Tools Co., Ltd. was established in 2011. In order to meet the diversified development of the company's business, the company has been rapidly upgraded to a new development platform to adapt to the ever-changing market pattern, and a product research and development center has been set up for the company to carry out the demonstration and research and development of various tool processing solutions according to market demand and development trends. Strive to make Ekart's various precision diamond cutting tool products at the forefront of the industry, and demonstrate the treatment plan for customers in the production process to provide high-quality solutions and fast after-sales service.



伊卡特尤尼莫克



展商名录 (按公司名称字母排序)

Exhibitors List by Alphabetical Order

EH102 - C21

HONGGUANG HANDAN CAST FOUNDRY CO., LTD

Add:NANKAI DISTRICT, XIAOZHAI TOWN,
JIZE COUNTY, HEBI, CHINA.057351

Email:hgcast@hdhgcast.com

Web:www.hdhgcast.com

Tel:+86-0310-7661887

Main Product:The Product Covers A Wide Range Of Products, Including Communications, Power, Pipeline Engineering, Airport And Municipal Infrastructure Used In Nodular Cast Iron Shaft Cover, Grate, Pipe Fittings, Automotive Accessories, Machinery Accessories, Agricultural Machinery Accessories, Cast Iron Cookers, Livestock Accessories.

Hongguang Handan Cast Foundry Co., Ltd. Was Founded In 1998. It Is Located In Jize County Foundry Industrial Park, Hebei Province, Covering An Area Of More Than 200 Mu.The Company Has Passed BSI System And Product Certification, Through ISO14001:2004 Environmental Management System Certification, OHSAS18001 Occupational Health And Safety Management System Certification; Strictly In Accordance With EN124 And Other International Standards For Testing. The Main Testing Equipment: Chemical Element Analysis Instrument, Spectrometer, Metallographic Microscope, Furnace Rapid Analyzer, Universal Physical.

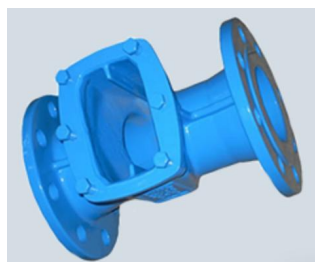
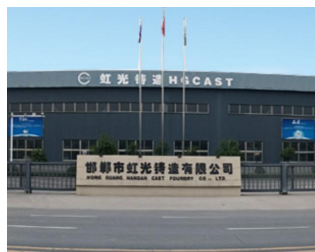

EH102 - C25
HANDAN ZHONGANG NEW MATERIAL
CO.,LTD.

Add:No. 456, Renmin Road, Handan City,
Hebei Province, China
Email:domestic@zhong-ang.com
Web:www.ccbead.com
Tel:+86-400-8067600

Main Product:CC sintered ceramic sand

Zhong Ang New Material is a new material technology company integrating R&D, production and technical service, with its factory located in Yangquan, Shanxi Province and offices in Hebei, Shandong, Anhui, Shanghai, Jiangsu, Guangdong and other places. The company is currently involved in foundry materials, refractory materials, building materials and other fields, the product market covers all major cities in China, exported to the United States, Europe, Japan, Korea, Southeast Asia, India and other countries and regions.

The company's leading products CC sintered ceramic sand series, meet the actual needs of the foundry industry for molding materials, with an annual output of up to 50,000 tons.

Zhong Ang New Material adheres to the business philosophy of "more saving, more environmentally friendly, and better quality", always maintains the original intention of "creating value for customers", builds brands, and promotes the green, low-carbon and efficient development of enterprises.



中昂新材

ZHONGANG NEW MATERIAL



展商名录 (按公司名称字母排序)

Exhibitors List by Alphabetical Order

EH102

Korea Foundry Society



KOREA FOUNDRY SOCIETY

사단법인 한국주조공학회

Address : #11, Yeongdeungporo 27 street,
Yeongdeungpo- gu, Seoul, Korea

Tel: +82-2-2069-2877

Fax: +82-2-2069-2879

E-mail: kfs@kfs.or.kr

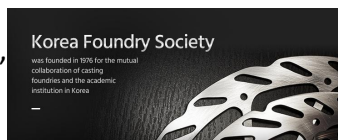

KFS has the following activities to contribute technology innovation in casting industries as well as academic progress;

1.Academic activities :

Academic conferences in spring, summer and autumn
Bimonthly publication of the KFS journal

2.Technology innovation :

Technical contest of castings
Quarterly issue of foundry bulletin

3.International collaboration :

Hosting international conferences(AFC, WFC, etc)
Other international events for academic exchanges(YFE, etc)

EH102 - C31
HANGZHOU YUANTONG STEEL SHOT
MANUFACTURING CO.,LTD

Add:Xinjie Town,Xiaoshan, Hangzhou
City,Zhejiang Province,China
Email:2637225440@qq.com
Tel:15267037038

Main Product:Chromium alloy steel shot 、
Steel Wire Cut Shot

Hangzhou Yuantong Steel Shot Manufacturing Co., Ltd. was established in June 1983, located in the picturesque Hangzhou, a city known as the paradise on earth. After more than forty years of stable development, the company has been honored with the titles of "Innovative Small and Medium-sized Enterprise" and "Specialized, Sophisticated, Characteristic and Novel Enterprise" by the government, and its influence is widely praised across the country.

The chromium alloy steel shot produced by our company stands out in the market with its remarkable characteristics such as high strength, excellent anti-fatigue performance, outstanding wear resistance and strengthening performance. Compared with the traditional cast steel shot, this product not only has a significantly longer usage life, but also has better use effect, which can help users save more than 50% of the cost.



展商名录 (按公司名称字母排序)

Exhibitors List by Alphabetical Order

EH102 - C20

**TIANSHU INDUCTION TECHNOLOGY
CO.,LTD**

天舒科技
TIANSHU INDUCTION

Add:No. 41 Xicheng Road, Xicheng
Development Zone, Shiyan City, Hubei
Province, China

Tel:086-0719-8569801

Email:zhaowei@ts-heating.com

Web:<http://www.ts-heating.com/>



Main Product:medium and high frequency,
transistor solid-state power supplies, various
general and special CNC induction
hardening machines, inductors, and
undertaking various hardening processing.



Tianshu Induction Technology Co., Ltd
(Tianshu Induction) was established in 2010.
The company is headquartered in Shiyan
City, Hubei Province, and currently has two
subsidiaries, four offices, and one enterprise
school joint innovation center. Tianshu
Induction has more than 120 employees,
including more than 40 professional
designers. The product has users in
industries such as internal combustion
engines, automotive parts, construction
machinery, machine tools, and metallurgy in
27 provinces and cities in China.

EH102 - A01
HUNAN ENVIRONMENTAL TECHNOLOGY.CO.,LTD
HUAZHONG-TIANDI PROTECTION

Add:No. 58, Chunma Road, Matang Town, Yueyang County, Yueyang City, Hunan Province, China
Email:hztddb@163.com
Web:www.hztddb.com
Tel:+86-730-7833399
Fax:+86-730-7830280

Main Product:Automatic Batching & Charging System for Electric Furnace, Complete Equipment of Dust and Exhaust Treatment for Foundries, Construction of Digital Intelligence Foundry Plant, Ladle Pre-heater

Hunan Huazhong-Tiandi Environmental Protection Technology Co., Ltd is the Leading Enterprise of Foundry Energy Saving and Automation Informatization Field. With more than 30-years' experience, Huazhong is specialized in products of Electric Furnace Automatic Batching & Charging System, Casting Dust and Exhaust Treatment, Ladle Pre-heater, High Temperature Weighing, and Construction of Digital Foundry.



展商名录 (按公司名称字母排序)

Exhibitors List by Alphabetical Order

EH102 - B19

HUIZHOU

GEPOINT

PRECISION

TECHNOLOGY CO., LTD.

GEPoint
吉邦精密

Add:2nd Changtang Industrial Park,Baihua
Town,Huidong County Huizhou
City,Guangdong Province,China

Email:jbwl@jbcasting.com

Web:www.jbcasting.com

Tel:+86-752-8785338

Main Product:Casting 、 CNC machining 、
Bending、 Stamp&bend

Jibang Precision is a global manufacturer of high-precision, high-reliability and high-complexity metal parts. Our products are used in auto parts, medical equipment, engineering machinery, food and beverage equipment,energy industry, security industry,etc. for diverse markets ,and provide global partners with reliable product and service solutions. Our manufacturing process covers investment casting, precision machining and assembly testing.



EH102 - A11

**Jiangsu Han's Smart Welding Equipment
Group Co., Ltd.**



Add:Plant A8,Dongjiu Garden 1199 Bihua
road,Tongzhou District,Nantong City,China

Tel:17354920969

Email:huangdh147835@hanslaser.com



Main Product:Laser welding, intelligent
welding assembly line, automated assembly
line

Jiangsu Han's Smart Welding Equipment
Group Co., Ltd, is a subsidiary of han's Laser
Technology Industry Group specializing in
intelligent welding production lines. It is
dedicated to the research and development,
manufacturing, sales, and service of laser
welding, intelligent welding assembly lines,
and automated assembly lines, providing
customers with comprehensive metal
connections, automated assembly, testing
technology, and advanced complete sets of
intelligent manufacturing equipment. It has
multiple leading technologies and rich
application experience

展商名录 (按公司名称字母排序)

Exhibitors List by Alphabetical Order

EH102 - B15

**JIANGSU JIAMING ADVANCED CARBON
MATERIALS CO.,LTD**

Add:Donghai County,Lianyungang

City,Jiangsu Province China

Email:nancy@jsjmco.com

Web:www.jsjmco.com

Tel:+86-518-87616889

Fax:+86-518-87776358

Main Product:Graphite petroleum
coke,Calcined petroleum coke,Carbon
electrode paste,Semi-GPC

Founded in 1992, the company covers more than 190,000 square meters and has four modern production workshops, a large warehousing workshop, a provincial laboratory and a research center of new energy material engineering.We always insists on scientific and technological innovation, focuses on new technologies and products of carbon materials, and actively expands application of results.

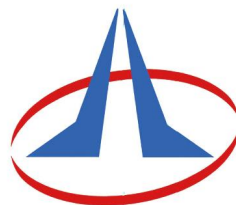

嘉明碳素

Jiaming Carbon



EH102 - A05
JIANGSU RENSEN CAST IRON CO.,LTD

Add:NO.26, QINGYANG ROAD, XINBEI DISTRICT, CHANGZHOU, JIANGSU PROVINCE, CHINA

Email:zhengwencai2005@163.com

Web:www.jsrsqt.com

Tel:+86-519-85153162-8005

Fax:+86-519-85161862

Main Product:metal materials : cast iron, scrap steel, silicon iron, manganese iron.ect; and all casting materials

Jiangsu RenShen Cast Iron Co., Ltd. established in 1993, has developed into a comprehensive enterprise integrating production, processing, and sales of casting raw and auxiliary materials.The company has an advanced casting pig iron warehouse with clear classification and standardized storage, making it a leading domestic distribution center for high-quality casting pig iron. At the same time, we are the Chinese agent for Russian "Tulachermet" casting pig iron, Japanese "Kaka" slag remover, "Xinfute" mold release agent, and refractory materials from the Allied mineral, providing a comprehensive casting material solution.



EH102 - C08

**JIANGSU TIANHONG MACHINERY
INDUSTRIES CO.,LTD.**



Add:Industrial Park, Douzhuang, Danyang,
Jiangsu, China

Email:jsthjx@vip.163.com

Web:www.tianhong-group.com

Tel:+86-511-86414888

Fax:+86-511-86058333

Main Product:LPDC machine

Jiangsu Tianhong Machinery Industry Co., Ltd. is a high-tech enterprise, specializing in R&D, manufacturing and marketing the high end intelligent equipment. It is situated in Douzhuang Industrial Zone, Danyang City with the registered capital of US\$10 Million, occupied land area of 26600m2, plant area of 11000m2 and 210 employees. It was founded in August 2007 and put into production in July 2009, mainly developing the intelligent casting equipment for Aluminum alloy foundries and other peripheral equipment, specialized equipment for Aluminum alloy wheel manufacturing, fixtures and chucks for precision machineries, such as CNC lathes and machining centers, etc. In 2011, the company started to develop the automatic production lines, serving for the industries of automotive components, high-speed train parts, equipment manufacturing and light weight castings of new energies automobiles, etc.

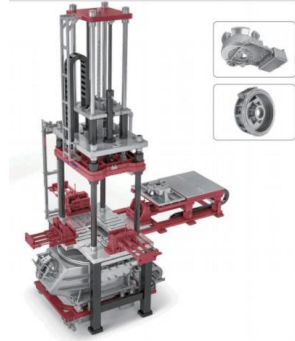

展商名录 (按公司名称字母排序)

Exhibitors List by Alphabetical Order

EH102 - B29

**LIAONING PRATE ENVIRONMENTAL
PROTECTION TECHNOLOGY CO. LTD**



Add: No.72, Xiaozhuang Street, Taizihe District, Liaoyang City

Email: lnputete@163.com

Tel: +86-419-2393999

Web: <http://www.lnplthb.top/>



Liaoning Prate Environmental Protection Technology Co. LTD is specialized in environmental protection equipment research and development, design, production and manufacturing, installation and commissioning, after-sales service, technical consultation as one of the science and technology enterprises. Our company has rich experience in dust and flue gas treatment. The side-inserted flat bag and low-pressure pulse long cloth bag dust removal equipment developed and produced by our company adopts blower or pulse valve back blowing, which is controlled by industrial PLC combined with sensor and frequency conversion technology to realize automatic operation and online monitoring of dust collector. The optimized products have the characteristics of less floor space, good filtration effect, low maintenance and operation cost, stability and reliability.



XIAOHE 14 PRO
2024.03.28 14:40:14

14mm f/2.2 1/575s ISO50
2024/03/28 14:40:14

EH102 - C28
Federation of Malaysian Foundry &
Engineering Industries Associations

展商名录 (按公司名称字母排序)

Exhibitors List by Alphabetical Order

EH102

Mongolian Metallurgical Association

EH102 - C22
**NANJING PUJIANG ALLOY MATERIALS CO.,
LTD.**

Add:Nanjing Pujiang Alloy Materials Co.,Ltd
Email:jevason@163.com
Web:www.njpujiang.com
Tel:+86-25-52249839
Fax:+86-25-52623887

Main Product:NODULIZER AND
INOCULANTS

PUJIANG SPECIALIZES IN SERIES PRODUCTS
OF VARIOUS SPECIFICATION FOR FOUNDRY
INDUSTRY SUCH AS NODULIZER,CORED
WIRE,INOCULANTS,MOULD INOCULANTS
AND MOULD POWDER FOR CASTING IRON
PIPE. ETC.WITH 80,000MT ANNUAL
PRODUCTION CAPACITY,70% OF OUR SALES
ARE EXPORTING TRADE.



展商名录 (按公司名称字母排序)

Exhibitors List by Alphabetical Order

EH102 - A30

**UNITED LASHING PRECISION CASTING
CORP.,LTD.**



Add:No.5 Tanxi Road Gaochun Industry
Zone,Nanjing,JS,China 211316

Email:Sharon@unitedlashing.com.cn

Web:www.unitedlashing.com.cn

Tel:025-68597779

Fax:025-68597797



Main Product:Gearbox parts; auto parts;
hardware castings; pump&valve parts;
railway&subway parts



UNITED LASHING PRECISION CASTING Co.,
Ltd. was established on December 23, 2008,
with an annual production capacity of 5000
tons of precision castings. Production
process: silica sol and coated sand process.
Material: Carbon steel, low alloy steel, high
alloy steel, stainless steel, etc. The company
mainly adopts automated production
methods and has advanced production
equipment such as wax automatic
production line, robot shell automatic
production line, semi-automatic melting and
pouring line, and automatic logistics
transmission line; At the same time,
possessing CNC processing ability, heat
treatment ability, surface treatment ability,
providing customers with one-stop delivery
service.



EH102 - A08
NANJING CHANGJIANG INDUSTRIAL
FURNACE TECHNOLOGY GROUP CO.,LTD.

Add:Nanjing Changjiang Industrial Furnace
Technology Group Co.,Ltd.
Email:nal@njcjd.com
Web:www.njcjd.com
Tel:+86-25-85704179

Main Product:no basket H/T production line

Our company is one of the large enterprises that design and manufacture various industrial furnaces and fuel furnaces.

Since its establishment in 1975, it has introduced and absorbed the advanced technology of the international famous furnace company, accumulated rich experience in design and manufacturing, and cultivated a strong technical team and excellent quality assurance system.

The products involve in the fields of aerospace and military industry and medical treatment, and contribute to China's "Shenzhou 5" spacecraft, as well as the manufacture of national defense equipment such as missiles, ships and planes.



展商名录 (按公司名称字母排序)
Exhibitors List by Alphabetical Order

EH102 - A30
Nanjing Foundry Association

Email:nj-foundry@163.com

Web:www.njzdxh.com

Tel:025-85016310

Fax:025-84489245

EH102 - A19
NANTONG PRATT MACHINERY CO., LTD

Add:No.366,West Huanghai Avenue,Haian City,Jiangsu Province
Email:pratt@prattjx.com
Web:<http://www.prattjx.com/>
Tel:0513-88709299
Fax:0513-88709696

Main Product:Includes sand mixing equipment, automatic molding lines, casting lines, sand treatment equipment, dust removal systems, and odor environmental protection equipment, cleaning devices, painting facilities, and more.

Nantong Pratt Machinery Co., Ltd. is a high-tech enterprise specializing in providing planning and design services for casting and painting workshops for users. The company is committed to the research and manufacturing of self-hardening sand casting equipment and painting equipment, providing turnkey engineering services including design, manufacturing, installation, commissioning, and technical consulting. Obtained ISO9001 international quality management system certification, Eurasian Economic Union EAC certification, ISO14001 environmental management system certification, and ISO45001 occupational health and safety management system certification. The company's products include sand mixing equipment, automated molding lines, pouring lines, sand processing equipment, dust and odor removal environmental protection equipment, cleaning equipment, painting equipment, etc.

PRATT®



展商名录 (按公司名称字母排序)

Exhibitors List by Alphabetical Order

EH102 - C06-2

**INNER MONGOLIA SQKLY NEW
MATERIALSTECHNOLOGY CO.,LTD.**

Add:Zhong tan Industrial Park,Wulat
Qianqi,Bayannur City,Inner Mongoila
Autonomous region,China

Email:keliyuan@keliyuan.ltd

Tel:+86-478-3232882

Fax:+86-478-3236882

Inner Mongolia Shengquan Keliyuan New Material Technology Co.,Ltd was established by Jinan Shengquan Group Share Holding Co., Ltd. joint venture with Inner Mongolia Keliyuan New Material Technology Co.,Ltd. This is a key strategic investment project of Jinan Shengquan Group Share Holding Co., Ltd., Annual output of 150000 tons of casting alloy production base will be built, the main products are various types of nodularizer, vermicularizing alloy, inoculant, and the corresponding cored wire products, ferrosilicon, ferromanganese, chromium iron, silicon barium alloy, rare earth silicon alloy, rare earth metals, hydrogen and rare earth reserve material.Inner Mongolia Shengquan Keliyuan New Material Technology Co.,Ltd is the largest manufacturer of special alloy and metallurgical products for casting in China. Relying on its leading technological advantages and raw material base, Inner Mongolia Shengquan Keliyuan New Material Technology Co.,Ltd provides customers with high-quality pro.

EH102 - C16

**NINGBO FANGGE MACHINERY
MANUFACTURING CO.,LTD**



Add:NO#78 Huanghai Road, Xinqi Street,
Beilun District

Email:2668830620@qq.com

Tel:18806801130



Main Product:Die-castings and Die-casting
mould

The company is engaged in the design, development and manufacture of automotive die-casting molds and die-casting products. It is a supporting enterprise for large domestic automobile manufacturers. We have a scientific management system and professional management and technical personnel to continuously provide customers with high-quality products and services. At present, we have more than 50 employees and various management and technical personnel. The company currently has different types of die-casting machines such as 280T, 400T, 500T, 800T, 1250T, more than 20 precision CNC lathes and machining centers, and mold design and manufacturing covers 280T to 3500T. The main testing equipment includes three-coordinate, imager, etc.

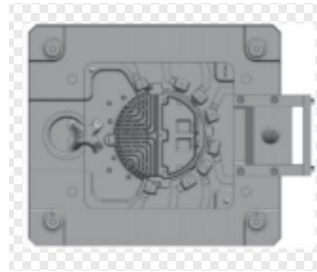

展商名录 (按公司名称字母排序)

Exhibitors List by Alphabetical Order

EH102 - A43

Ningbo Jisheng Casting Co., Ltd.

Add:Address: No. 1, Bianjia, Yanshan Village,
Yinjiang Town, Haishu District, Ningbo City,
Zhejiang Province

Tel:0574-88029540

Web:www.nbmetal.com

Email: sales@nbmetal.com

Main Product:Aluminum alloy casting, zinc
alloy casting, mechanical processing

Ningbo Jisheng Casting Co., Ltd. is located in Haishu District, Ningbo City, Zhejiang Province, close to Ningbo International Airport. Founded in 2017, the company is a professional manufacturing and exporting enterprise integrating scientific research, development, production and sales of zinc alloy, aluminum alloy, and copper castings. After years of concentrated operation, the company has been recognized as the best in the foundry industry and has entered the forefront of the industry. After entering the market for more than 20 years, the products involved include auto parts, construction machinery parts, hydraulic pump valve bodies, transportation facilities parts, pneumatic tool parts, ship parts, etc. The customer base covers all parts of the country, and most of the industrial products are exported to the United States, Markets such as Germany, Italy, Asia.



EH102 - B31
NINGBO SHENGUANG ELECTRIC FURNACE
CO.,LTD.

Add:Yushantou Industrial Zone,Dongqiao
Town,Haishu District,Ningbo City
Email:nbsgdl@126.com
Web:www.nb-shenguang.com
Tel:+86-574-88270190
Fax:+86-574-88270190

Main Product:Medium frequency electric
furnace, power frequency furnace, vacuum
furnace, medium frequency diathermy
furnace

Ningbo Shenguang Electric Furnace Co., Ltd.
(innovation board, enterprise code 781659) has
been established for more than 27 years. It is a
professional induction furnace manufacturing and
R & D enterprise, a3-25 exhibitor of private
enterprise pavilion of Shanghai World Expo,
high-tech enterprise and director unit of smelting
branch of China Casting Association. The VIP series
inverter medium frequency electric furnace (one
to one, one to two, one to three, etc.) produced
by the company adopts the latest international
technology and is widely used in heating,
diathermy, quenching, vacuum furnace smelting,
etc.

The company's products are exported to all over
the world. With the purpose of quality first and
customer first, we warmly welcome customers to
negotiate and order.



展商名录 (按公司名称字母排序)

Exhibitors List by Alphabetical Order

EH102 - A32

NINGBO SPEY TECHNOLOGY CO.,LTD.

Add:NO.92 XUEDOUSHAN ROAD, XIEXI INDUSTRIAL ESTATE, DAXIE DEVELOPMENT ZONE, NINGBO, ZHEJIANG, 315812, CHINA.

Email:spey@china-spey.com

Web:www.china-spey.com

Tel:+86-574-86761355

Main Product: Mainly produces components for automobiles (automobile lightweight), general-purpose engines, motorcycles (including ATV, UTV, etc.), power tools and other precision aluminum die-casting parts

Ningbo Spey Technology Co., Ltd. was founded in 1994 and mainly produces components for automobiles (automobile lightweight), general-purpose engines, motorcycles (including ATV, UTV, etc.), power tools and other precision aluminum die-casting parts. Currently, three factories have been built (2 in Ningbo and 1 in Jiangmen, Guangdong), with nearly 1,300 employees. The 4th factory (Ningbo) and the 5th factory (Thailand) are under construction.

SPEY
斯贝科技



EH102 - A41
Ningbo Tianye Precision Casting Co.,Ltd.

Add: Jiulong-Lake Economic Development Area, Zhenhai, Ningbo, Zhejiang, China
Tel: +86-574-86530988; +86-574-86531196
Email: sales@tianyecasting.com
Web: www.tianye-casting.com

Main Product: Transmission Systems parts, Exhaust Systems parts, Power Tools parts, Power Supply Systems parts, etc.

Funded in 2001, focused on casting steels, stainless steels and brass alloy investment casting, with a 3500 tons/year in total capacity. With 230 employees and a 30-person technical department, the company has been qualified to IATF16949 since 2008.



展商名录 (按公司名称字母排序)

Exhibitors List by Alphabetical Order

EH102 - A31

NINGBO YINRUN AUTO PARTS CO.,LTD

Add: No. 8 Yantanghe Road, Beilun District,
Ningbo City, Zhejiang Province

Email:yinrun08@163.com

Tel:+86-574-86133006

Web:<http://nbyinrun.com/>

Main Product:Aluminum die castings

Ningbo Yinrun Automotive Parts Co., Ltd. is an enterprise with independent research and development design capabilities, specializing in the manufacturing of high-precision die-casting molds and die-casting components. We mainly produce automotive components, as well as some communication, electric tools, and household appliance components. The company strictly establishes a quality management system in accordance with industry standards and has passed ISO9001:2008 certification and IATF16949:2016 automotive industry quality management system certification.



EH102 - A07
KOCEL INTELLIGENT MACHINERY(ANHUI) LIMITED

Add: Chungu 3D Printing Industrial Park ,
Fanchang Economic Development Zone,
Wuhu, Anhui Province, China
Email: jiyun.cai@kocel.com
Tel: 18295205676

Main Product: Binder injection
(casting/metal/ceramic) 3D printing
equipment R & D and manufacturing, 3D
printing digital factory construction, 3D
printing products and services, precision
sheet metal and auxiliary machine
manufacturing

KOCEL will show you parts and castings
manufactured by using 3D printing and
rapid prototyping technique, they are
engine block, cylinder, robots body , high
speed & precision turning & milling center
bed, hydraulic valve body, etc. All these are
complex castings. Besides, there are also
finish machining castings, such as head and
blade carrier in the exhibition booth. In
KOCEL booth, there is a whole solution
capability exhibition of the first-class casting
and machining.



KOCEL 共享
蔡奇芸
推广专员
共享智能装备(安徽)有限公司
地址: 安徽省芜湖市繁昌经济开发区春谷3D打印产业园
分厂地址: 安徽省芜湖市繁昌经济开发区春谷3D打印产业园
邮政编码: 241000/750021 电话: +86-18295205676
邮箱: jiyun.cai@kocel.com Http://www.kocel.com/

KOCEL
JiYun Cai
Promotion Specialist
KOCEL INTELLIGENT MACHINERY (ANHUI) LIMITED
Add: Chungu 3D Printing Industrial Park, Fanchang Economic Development Zone, Wuhu, Anhui, China
Subsidiary Add: 298# South Ningguo Road, Wuxi District, Wuxi City, Jiangsu, China
Postcode: 241000/750021 Tel: +86-18295205676
Email: jiyun.cai@kocel.com Http://www.kocel.com/

KOCEL 共享
蔡奇芸
推广专员
共享智能装备(安徽)有限公司
地址: 安徽省芜湖市繁昌经济开发区春谷3D打印产业园
分厂地址: 安徽省芜湖市繁昌经济开发区春谷3D打印产业园
邮政编码: 241000/750021 电话: +86-18295205676
邮箱: jiyun.cai@kocel.com Http://www.kocel.com/

KOCEL
JiYun Cai
Promotion Specialist
KOCEL INTELLIGENT MACHINERY (ANHUI) LIMITED
Add: Chungu 3D Printing Industrial Park, Fanchang Economic Development Zone, Wuhu, Anhui, China
Subsidiary Add: 298# South Ningguo Road, Wuxi District, Wuxi City, Jiangsu, China
Postcode: 241000/750021 Tel: +86-18295205676
Email: jiyun.cai@kocel.com Http://www.kocel.com/

展商名录 (按公司名称字母排序)

Exhibitors List by Alphabetical Order

EH102 - B07

**QINGDAO BENOR MAGNETOELECTRIC
TECHNOLOGY CO.,LTD.**



Add:DOUGOU VILLAGE,JIAOXI
TOWN,JIAOZHOU CITY,QINGDAO CHINA

Email:zhushijia@qdbn.cn

Web:www.qdbn.cn

Tel:+86-532-85205888

Fax:+86-532-85202288



Main Product:Electric Furnace Vibrate
Feeding Charger 、 Electric Furnace Dust
Removal Equipment、 Alloy Automatic Bat



Our company mainly produce models of
Electric Furnace Auto-batch weighing and
smelting monitor&manage system 、 Crane
Electromagneti

EH102 - A09
QINGDAO HAO SHENG DA CASTING
MACHINERY CO.,LTD.



Add:Tianzhaung Town,Pingdu City ,Qingdao,
Shandong

Email:info@haoshengda.com

Web:www.haoshengda.com

Tel:+86-532-86383566

Fax:+86-532-86385319

Main Product:Shell mold shell core
production line, Regenerating line of coated
sand, Clay sand production line, Resin sand
production line , Cold box core shooting
machine, Hot box core shooting machine

Qingdao HaoSheng of Casting Machine Co., Ltd.
located in Qingdao pingdu grange industrial park,
is a specialized production factory, casting
machinery and mining machinery to produce all
kinds of high quality clay sand, In order to fully
realize the automation of casting production, forge
ahead on the road of manufacturing world-class
equipment.The company's business is divided into
sand treatment, core shooting machine and dust
removal system, The main products are clay sand
production line, resin sand production line, shell
mold line, coated sand used sand regeneration line,
cold core box core shooter, hot core box core
shooter, shell core shooter, workshop dust
removal system, casting grinding dust removal and
other products.

展商名录 (按公司名称字母排序)

Exhibitors List by Alphabetical Order

EH102 - C11

**QINGDAO HUACAN HEAVY INDUSTRY CO.,
LTD**

Add:No.381,haibin seven road,huangdao
district,qingdao

Email:allenhuacan@126.com

Web:www.qdhuacan.com

Tel:+86-532-85135899

Fax:+86-532-85135898

Main Product:shot blasting
machine,molding machine , core making
machine,dust collector,sand production line



EH102 - B11
Qingdao Obolin Environmental Protection Equipment Co., Ltd.

Tel:086-0532-86380018

Email:13156378288@163.com

Web:WWW.tianhuiji.com

Main Product:Plastic sintered plate dust collector, side plug-in flat bag dust collector, pulse dust collector

Qingdao Oubolin Environmental Protection Equipment Co., Ltd. is located in the west of Jiaodong Peninsula, north of Weilai Expressway exit, is a collection of air pollution control in the field of environmental engineering system design, bag dust removal and desulfurization and denitrification product design, manufacturing, sales and service as one of the flue gas purification solution providers, is one of the largest bag dust removal equipment professional manufacturing enterprises, focusing on PM2.5 fine particulate matter control and industrial dust removal flue gas treatment solutions to provide. Chairman: Liu Yongwei. Telephone: 13953231210.



展商名录 (按公司名称字母排序)

Exhibitors List by Alphabetical Order

EH102 - B11

Qingdao Tianhui Yizhuo Machinery Technology Co., Ltd.

Tianzhuang Town, Pingdu City, Qingdao City, east of the middle section of Yuxing Road

Tel:086-0532-86380018

Email:13156378288@163.com

Web:WWW.tianhuizj.com

Main Product:Sand mixer, double-disc stirring cooler, sand removal cleaning drum

Qingdao Tianhui Yizhuo Machinery Technology Co., Ltd. is a professional manufacturer of foundry machinery, located in the west of Jiaodong Peninsula, north of Weilai Expressway exit, covering an area of 49,680 square meters, construction area of 38,000 square meters, fixed assets of 380 million, 468 employees, 46 technicians, 22 senior engineers, specializing in the production of 3000-60000t/h casting condensation resin sand mechanized production line, 50-200t/h mechanized water glass sand treatment production line turnkey project. Chairman: Liu Yongwei. Telephone: 13953231210.



EH102 - B11
QINGDAO TIANHUI INTELLIGENT
MACHINERY TECHNOLOGY CO., LTD.

Add:Industrial Park, Tian Zhuang Town,
Pingdu City, Qi

Email:1543571467@qq.com

Web:www.tianhuizj.com

Tel:+86-532-86380018

Fax:+86-532-86388297

Main Product:Sand mixer, double plate
mixing cooler, sand falling drum and other
equipment

Qingdao Tianhui Foundry Machinery Co., Ltd.
is a professional foundry machinery
manufacturer. It is located in the west of
Jiaodong Peninsula and the north side of
Weilai expressway exit. It covers an area of
49680 square meters, with a construction
area of 38000 square meters, fixed assets of
380 million, 468 employees, 46 technicians
and 22 senior engineers. It specializes in the
production of 3000-60000t / h casting
condensed resin sand mechanized
production line and 50-200t / h mechanized
water glass Turn key project of glass sand
treatment production line. Chairman: Liu
Yongwei. Tel: 13953231210



天汇集团
TIAN HUI GROUP



展商名录 (按公司名称字母排序)

Exhibitors List by Alphabetical Order

EH102 - B11

QINGDAO TIANHUI MACHINERY CO., LTD.

Add:Industrial Park, Tian Zhuang Town,
Pingdu City, Qi

Email:1543571467@qq.com

Web:www.tianhuijz.com

Tel:+86-532-86380018

Fax:+86-532-86388297

Main Product:Sand mixer, double plate
mixing cooler, sand falling drum and other
equipment

Qingdao Tianhui Foundry Machinery Co., Ltd.
is a professional foundry machinery
manufacturer. It is located in the west of
Jiaodong Peninsula and the north side of
Weilai expressway exit. It covers an area of
49680 square meters, with a construction
area of 38000 square meters, fixed assets of
380 million, 468 employees, 46 technicians
and 22 senior engineers. It specializes in the
production of 3000-60000t / h casting
condensed resin sand mechanized
production line and 50-200t / h mechanized
water glass Turn key project of glass sand
treatment production line. Chairman: Liu
Yongwei. Tel: 13953231210



EH102 - B26
CHINA·JUNENG MACHINERY



Add:No.16 Ling'an road (Wuli Industrial Area), Jinjiang City Economic development zone, Fujian, China

Email:zoe@junengmachine.com

Web:www.junengmachine.com

Tel:+86-130 3099 8585

Fax:+86-595-88163029



Main Product:Automatic molding machines

JUNENG Machinery mainly produces casting molding production lines, adheres to the business philosophy of "market-oriented, quality-winning", relies on high technology, and continuously strives for progress and innovation. The technical level and industry competitiveness are continuously improving. JUNENG Machinery has become one of the few domestic manufacturers that integrate R&D, design, manufacturing, sales, and service. It provides a comprehensive manufacturing service for diversified, intelligent, and personalized casting molding lines. It offers fully automated, highly reliable, and cost-effective automatic molding equipment for numerous small and medium-sized foundry enterprises.

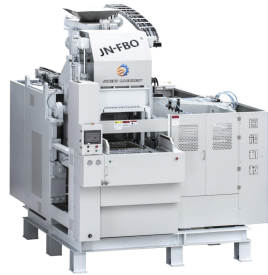

展商名录 (按公司名称字母排序)

Exhibitors List by Alphabetical Order

EH102

Japan Foundry Society

Tel:03-34311375

Web:www.foundry.jp

Email:koshin@foundry.jp

The association's members are companies and organizations that manufacture and sell castings, casting machinery, raw materials, auxiliary materials, software, recycling, etc. Its distinctive feature is its multi-layered structure that allows participation from a wide range of industries surrounding the casting industry. In addition, it covers the majority of the casting manufacturing industry in Japan, making it the core and comprehensive organization for the entire casting industry.



EH102 - B26

Xiamen Shengda Kaijia Machinery Co., Ltd.

展商名录 (按公司名称字母排序)

Exhibitors List by Alphabetical Order

EH102 - B36

**SHANDONG HUIDA VERMICULAR
GRAPHITE EQUIPMENT CO., LTD.**

Add:No. 15266 Shouji Road, Tangshan Town,
Huantai County, Zibo City, Shandong
Province

Email:hdrmzb@hdrmzb.com

Web:hdrmzb.com

Tel:+86-533-8510473

Main Product:Ferrous metal casting;
Manufacturing of metallurgical specialized
equipment (excluding licensed professional
equipment manufacturing); Manufacturing of
specialized machinery for tunnel construction:
Construction machinery manufacturing and
equipment leasing; Sales of mechanical equipment;
Automobile wheel hub manufacturing;
Manufacturing of railway locomotive and vehicle
accessories: manufacturing and sales of
high-speed railway equipment and accessories;
Research and development of mechanical
equipment: processing and sales of mechanical
parts and components; specialized equipment and
key systems for rail transit; Technical services,
development, exchange, and transfer; Import and
export of goods; Sales and rental of special
equipment; Manufacturing and sales of forgings
and powder metallurgy products; Automotive
component research and development and
accessory manufacturing; Manufacturing of urban
rail transit equipment and sales of components;
Metal structure manufacturing;



展商名录 (按公司名称字母排序)
Exhibitors List by Alphabetical Order

Shandong Huida Vermicular Iron Equipment Co., Ltd. is located in Huantai County, Zibo City, Shandong Province. It is an internationally renowned professional manufacturer of vermicular iron. It has hosted multiple national seminars on vermicular iron technology and participated in the drafting and formulation of two national standards. The company has multiple production lines and processing and testing equipment, with an annual output of up to 100000 tons. Its products have won the "Gold Award for High Quality Castings" multiple times, and in addition, it continues to expand the research and practice of new products. The company has comprehensively passed multiple management system certifications and meets UKAS standards.

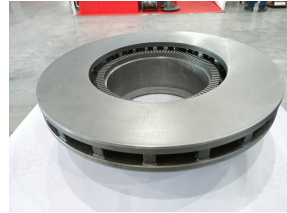

展商名录 (按公司名称字母排序)

Exhibitors List by Alphabetical Order

EH102 - B09

**SHAN DONG JIE CHUANG MACHINERY
CO.,LTD**

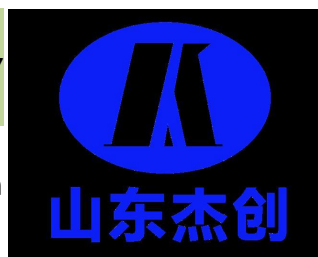

Add:No. 138 Xinzhuang West Road, South
Huaiyin District, Jinan

Email:15688886786@163.com

Web:www.shandongjiechuang.com

Tel:+86-531-87977297

Fax:+86-531-87162257

Main Product: Intelligent automatic pouring
machine, intelligent automatic transfer of
hot metal, cold and Hot box core shooting
machine, robot automatic integrated
application

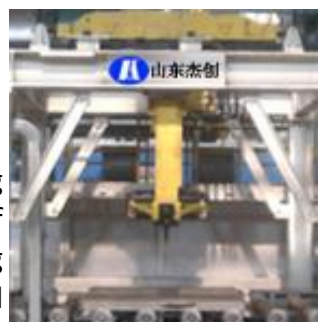

Shandong Jiechuang is a high-tech enterprise in Shandong Province, which focuses on the research and development of high-end intelligent casting equipment. For the domestic supply of intelligent hot metal transfer system and intelligent pouring machine leading enterprises. Relying on its strong technical force and YEARS OF EXPERIENCE IN R & D, Manufacturing and application, the company has 47 intellectual property items of state patented technology and computer software copyright, took the lead in drafting the national industry standard for the automatic transfer system of hot metal 1 and won the national advanced foundry machinery standard collective. The company provides the best solution for the customer widely by the outstanding innovation ability; satisfies the customer biggest wish by the good faith management, the customer is supreme idea.



EH102 - C06-3
SHANDONG CASEN INDUSTRIAL
EQUIPMENT CO.,LTD



Add:No. 13178, Cangnan Street, Lebushan Industrial Zone, Weicheng District, Weifang City, Shandong Province

Email:zhouxuan@casen-group.com

Web:www.zhuluqi.com

Tel:+86-536-8137266

Fax:+86-536-8137577

Main Product:Intermediate frequency furnace Vibrator



Shandong Casen is committed to building brand globalization, promoting the rapid development of technology and quality through continuous innovation, and always insisting on providing customers with high-quality products and services; At present, there are more than 1200 projects at home and abroad, and the products are exported to more than 30 countries and regions. Professional technical solutions, excellent quality control and professional services have won unanimous praise from customers at home and abroad!

展商名录 (按公司名称字母排序)

Exhibitors List by Alphabetical Order

EH102 - C06-1

**SHANDONG RONGTAI INDUCTION
TECHNOLOGY CO., LTD.**



Add:NO.1872, Fengxiang Street, Fangzi
District,Weifang City,Shandong

Province,China

Email:padraic@erongtai.com

Web:www.erongtai.com

www.rontaimelting.com

Tel:0086 152 6961 6086

Fax:+86-536-3083639

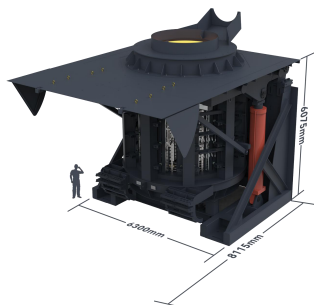

Main Product:Induction Melting Furnace;
Induction Heating Furnace

Shandong Rongtai Induction Technology was founded in 1997 and belongs to the high-end equipment manufacturer-Himile Group. For 27 years, it has focused on providing users with stable and efficient mid-frequency induction heating complete sets of equipment, smelting equipment, induction heat treatment equipment, etc., covering metallurgy, casting, forging, Heat treatment and other fields, serving many metal thermal processing companies at home and abroad.



We are committed to providing high-quality, cost-effective mid-frequency equipment for the metal thermal processing industry and creating a world-class metal thermal processing equipment brand!

EH102 - B23
SHANDONG YONGCHUANG CASTING
MATERIAL CO.,LTD.



Add:Zhucheng City,Shandong Province,
P.R.China

Email:sales@sinoyongchuang.com

Tel:0086-0536-6427866

Fax:0086-0536-6480288

Web:<http://www.sdyongchuang.com/>



Shandong Yongchuang Material Technology Co., Ltd. was founded in 2006, the company has been committed to the innovation and research and development of high-performance resin new materials, the main products are furan resin, phenolic resin, casting industry chain auxiliary materials and other high-end new materials. At present, it is used in aerospace, circuit packaging, wind power photovoltaic, high-end equipment and other fields, and its business covers many countries and regions such as South Korea and Southeast Asia, and now provides new material products and services for global customers. Furan resin global market share ranks among the top three in the country, in the forefront of the world.



展商名录 (按公司名称字母排序)

Exhibitors List by Alphabetical Order

EH102 - B17

SHANDONG USEEN CASTING CO., LTD.

Add: Wendeng Village, Shaozhuang Town,
Qingzhou City, Weifang, Shandong
Province,China.

Email:sales@useencorp.com

Web:www.useencasting.com

Tel:0536-5800337

Main Product:Wind power castings,
automotive molds, ingot molds, machine
tool accessories, counterweights,
automotive accessories

Shandong Useen Casting Co., Ltd. was established in 2014. The company has six divisions, including Casting Department 1, Casting Department 2, Casting Department 3, Machining Department, Mold Department, and Pig Iron Smelting Department for Casting, as well as a technology research and development center, with total assets of 1.3 billion yuan. It has an annual production capacity of 350,000 tons of pig iron and 170,000 tons of various castings.

It is mainly engaged in the research, development, production and sales of steel ingot molds, alloy ingot molds, machine tool castings, automotive molds, wind power castings, automotive parts, engineering machinery castings and pig iron for casting.



EH102 - C07

Shanxi Hando Xinyu Technology Co., Ltd.

Add: No.2-4 Nancun Green Casting
Innovation Industrial Park, Nancun Town,
Zezhou County, Jincheng City, Shanxi
Province, China

Tel: +86-13203460124

Email: sales@hando.com.cn

Web: www.hando.com.cn

Main Product: Flange ; Brake disc ; Benz
support ; Wabtec brake head ; CNH Diff
housing

Hando has perfect production equipment,
including casting, machining, heat treatment ,
surface coating and other processes. At present, it
has 3 automated production lines: one vertical
molding line, one Shinto horizontal molding line,
and one Permanent molding line, all equipped
with independent Inductotherm melting electric
furnaces and automatic pouring system.

Meanwhile, it is equipped with independent
Inspection laboratory, including spectrochemical
composition analysis, metallographic testing,
mechanical properties testing, RT,MPI, UT and
other testing methods. In terms of machining
workshop, Hando has more than 90 sets of
modern CNC machines such as Mazak, Feeler,
Hyundai WIA, and Youji, and is equipped with a
variety of detection means such as CMM,
Profilometer, Roundness tester, Automatic Optical
Inspection Device, and so on.



展商名录 (按公司名称字母排序)

Exhibitors List by Alphabetical Order

EH102 - A10

**SHANGHAI XINYAN INDUSTRIAL
EQUIPMENT CO., LTD.**



新研工业
XINYAN INDUSTRY

Add:No.128 Xian Gong Rd., Fengxian District, Shanghai

Email:contact@xinyanindustry.com

Web:www.xinyanindustry.com

Tel:+86-21-66876977

Fax:+86-21-66876978

Main Product:Induction melting system, pouring system , vacuum induction furnace, molten iron transport system , heating system

XinYan is specialized in developing,manufacturing,sales and service of induction melting system ,heating system ,automatic pouring system ,molten iron transport system and vacuum induction furnace with furnace capacity range from 0.1T to 90T,and power supply rated power range from 60KW to 36000KW.



EH102 - A25
SHENZHEN HAIGU TECH CO., LTD



Add: Longgang Zhenzhen China
Email: info@haigucasting.com
Web: www.haigucasting.com
Tel: +86-755-84183336

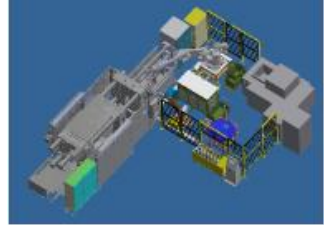

Main Product: high-quality semi-solid die-casting machine

Shenzhen Haigu TECH Co., Ltd. specializes in high-quality semi-solid die-casting products. Semi-solid die-casting products can reduce casting defects effectively such as sand holes, pores, shrinkage holes and so on. Especially it is suitable for structural parts and Mechanical parts die-casting products in automotive industry field with high quality requirements and high-conductivity die-casting products in communication field.



展商名录 (按公司名称字母排序)

Exhibitors List by Alphabetical Order

EH102 - A25

**Shenzhen ZhuChang technology
Management Consulting Co., Ltd.**

EH102 - C15
SHENYANG Z&F GRINDING WHEEL CO.,LTD

Add:No.6,HerongRoad,ShenyangArea,China(Liaoning)PilotFreeTradeZone
Email:syzfsl5555@163.com
Tel:+86-88327955
Web:www.zf.com

Main Product:Grinding Wheel 、 SUPER ABRASIVE PRODUCTS 、 CASTING GRINDING WHEELS

Companies leading products: roll grinding wheel : the diameter is from 400mm to1250mm for cold rolling and hot roll grinding wheel; grinding wheel for grinding bearings: cylindrical grinding wheels and screw fastening grinding wheel; grinding wheel auto parts: rail grinding wheel and so on.

The company not only produces the ordinary wheels which are diameters from 400mm-1250mm, thickness below 200, pore size and different models used in all sectors of various , and also are the specialized

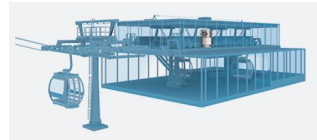
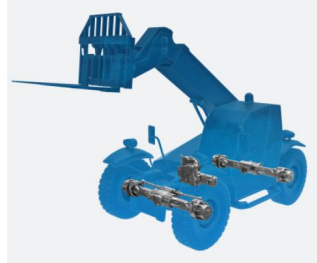

展商名录 (按公司名称字母排序)

Exhibitors List by Alphabetical Order

EH102 - C05-2

HDM Technology(Thailand) Co., Ltd.

Add:215/93 Asoke Tower condominium,21
Sukhumvit Road, Khlong Toei Nuea,
Watthana, Bangkok 10110
Tel:52549217

Main Product:HDM- vacuum pump oil /
HDM-Food grade lubricant / HDM hydraulic
oil /HDM air compressor oil

HDM Technology(Thailand) LTD The
registered capital of the department is 150
million baht Investment and construction
of 30000 square meters of advanced
production line and laboratory in ROJANA
Industrial Zone, Ayutthaya, Thailand An
innovative technology enterprise engaged in
R&D and production of special lubricants
and greases as well as import and export
trade HDM technology has been inherited
from Huifeng special lubricating materials
for more than 30 years Rooted in Thailand
serving the world, integrating advantageous
resources, adhering to innovation, daring
to make breakthroughs, working together
and win-win cooperation.



30-year brand of special
lubricating grease
特种润滑油脂30年品牌



EH102 - A15

Suzhou Clarkson Activated Carbon Co., Ltd.

Add:No. 388 Liandong Road, Linhu Town,
Wuzhong District, Suzhou City, Jiangsu
Province

Tel:086-0512-66205024

Web:<http://www.clarksoncarbon.com>

Email: bellaxia@clarksoncarbon.com

Main Product:CLKS600/700 honeycomb
activated carbon, CC800-1500 columnar
carbon series products, B-Diamond series
carrier carbon, WW2020-JP ultra long acting
catalyst, MQI-C new catalytic

CLARKSON CARBON is headquartered in
Suzhou, Jiangsu Province, and has two
branch factories nationwide. It has 6 offices
and 9 service branches in important cities
and regions across the country, with over
15000 installations, providing services to
more than 3500 domestic and foreign user
units. In addition, Clarkson established
CLARKSON CARBON (Malaysia) in March
2020. We look forward to deepening our
cooperation with more domestic and
foreign enterprises and better serving every
enterprise and consumer.



克拉克森

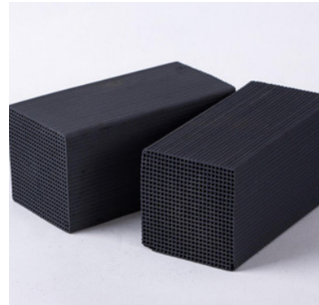

展商名录 (按公司名称字母排序)

Exhibitors List by Alphabetical Order

EH102 - B20

SUZHOU PUSIXIN MACHINERY CO.,LTD.

Add: Add: No. 688 FanFeng Road. Wuzhong District. Suzhou. Jiangsu

Email: psx_2011@126.com

Web: <https://www.psxjx.com>

Tel: +86-13812792695



Main Product: continuous sand mixer、 fixed single arm mixer、 Automatic temperature control liquid storage barrel 、 Fixed double arm mixer、 Lift type double arm mixer、 Mobile dual arm mixer、 Dry furnace 、 Flip flow coating machine、 Flip molding machine 、 Fully automatic four jaw box closing machine、 Transfer car and motor roller table 、 Vibratory platform、 Vibratory knock-out machine、 Vibration shakeout and crushing machine 、 side sand vibrating shakeout machine 、 crushing regenerator、 centrifugal regenerator、 Mill rubbing and Reclaimer 、 Horizontal boiling cooling bed 、 Vertical boiling cooler、 Sand temperature regulator



continuous sand mixer、 fixed single arm mixer、 Automatic temperature control liquid storage barrel 、 Fixed double arm mixer、 Lift type double arm mixer、 Mobile dual arm mixer、 Dry furnace 、 Flip flow coating machine、 Flip molding machine、 Fully automatic four jaw box closing machine 、 Transfer car and motor roller table 、 Vibratory platform、 Vibratory knock-out machine、 Vibration shakeout and crushing machine 、 side sand vibrating shakeout machine 、 crushing regenerator、 centrifugal regenerator、 Mill rubbing and Reclaimer 、 Horizontal boiling cooling bed 、 Vertical boiling cooler、 Sand temperature regulator

EH102 - C13
Taiwan Casting Industry Association

展商名录 (按公司名称字母排序)

Exhibitors List by Alphabetical Order

EH102 - B27

**THAI TOOL AND DIE INDUSTRY
ASSOCIATION**

Add : 86/6 Soi Trimitr, Rama IV Rd.,

Klongtoey, Bangkok 10110

Tel: +66 875591878

Email : tdia.su@hotmail.com

Web : www.tdia.or.th



It is well-known that tools and dies are the essence of industrial manufacturing, as in the case of Thailand they play a supportive role to other industries such as the automobile industry, electrical appliances industry, electronics industry, and so on. It is, therefore, necessary to perpetually develop the industry to meet with the striking growth of the demand both at home and abroad as well as to keep pace with modern production technology.

Thai Tool and Die Industry Forum was formed in 1989 and was subsequently upgraded to become the Thai Tool and Die Industry Association in 1992, with the aim to be a core center for Mould and Die Industry. Now TDIA has about 500 members and a Board of Directors which is comprised of 15 people.

EH102 - B28

Thai Machinery Association

Add: 86/6 1st Floor ,Division of Innovation and Industrial Technology Development, Soi Trimit, Rama IV Road, Klongtoey, Bangkok 10110

Tel: 02-712-2096

Fax: 02-712-2979

Email: officethaimachine2@gmail.com,
thaimachinery2@gmail.com

thaimachinery2@hotmail.com,

thaimachinery@yahoo.com

Web: www.thai-machinery.or.th



The THAI MACHINERY ASSOCIATION or TMA was established on November 13, 2001 and it now boasts 340 companies as member. The Thai machinery industry has progressed and developed into a stronger force thanks to cooperation among the members and directors of the Thai Machinery Association (TMA), as well as its advisers, experts and the public and private sectors. All of these stakeholders understand the real issues surrounding the obstacles to development of the industry.

展商名录 (按公司名称字母排序)

Exhibitors List by Alphabetical Order

EH102 - A12

Jamear co.,ltd

EH102 - B03

THAI FOUNDRY ASSOCIATION

Add:86/6,1st floor,BSID Building,Soi Trimitr,Bureau of Supporting Industries Development,Rama IV Rd.,Klongtoey,Bangkok 10110,Thailand.

Email:manager@thaifoundry.com/admin@thaifoundry.com

Web:www.thaifoundry.com

Tel:+662 712 2391

Fax:+662 712 2392



展商名录 (按公司名称字母排序)

Exhibitors List by Alphabetical Order

EH102 - B24

**Qinxin Group Tianjin Dahua Ocean
International Trade Co. Ltd.**

Add:19-1601, Wantong xincheng
International, Fifth Street, Binhai New Area,
Tianjin

Email:hanxulin0@163.com

Tel:8615934113535

Main Product:Foundry Coke

Tianjin Dahua International Trade Co., Ltd. is a wholly-owned subsidiary of Qinxin Group dedicated to export. When Qinxin Group first established its factory, it established the development idea of developing "high-quality cast coke" because the local area had high-quality main coking coal and excellent special furnace types for foundry coke.



EH102 - C29

TIANJIN UNO NEW MATERIALS CO.,LTD.

UNO 宇野

天津市宇野新材料有限公司

Add:Rm 708,Block B,Financial street
center,Haiguangsi,Nankai
District,Tianjin,China.

Email:bob.zhao@unomin.com

Web:www.unomin.com

Tel:+86-22-58956133

Fax:+86-22-58956100



Main Product:Silicon Carbide



Established in 2005, UNO International is one of the largest producers and stockist of Silicon carbide in China.

Our products are applied in the industries of foundry, refractory and abrasives as well as photovoltaic industry .

Our manufacturing facilities are in Ningxia with annual production capability of 30,000 tons .

Our stock warehouse is based in Tianjin with storage of SiC 6,000 tons to cater to your urgent demand for immediate delivery and is only 15 kilometers away from XINGANG PORT.



Being professional and premium quality in Silicon Carbide manufacturing and our understanding of the need of customers have helped us in establishing a long term business relationship with our customers around the world and they are from U.S., U.K., Poland, India, Malaysia, Japan, and South Africa etc.

展商名录 (按公司名称字母排序)

Exhibitors List by Alphabetical Order

EH102 - C02

WEBERST

INDUCTION

TECHNOLOGY(CHANGZHOU)CO.,LTD.

EH102 - A18
WOLLMANN TECHNOLOGY
(ZHANGJIAGANG) CO., LTD.

Add:Suzhou,Jiangsu,China
Email:juan.w@wollmann-tech.com
Web:www.wollmann-tech.com
Tel:0512-5855-0699

Main Product:Turbine Wheels Turbine
BladesSpindle、 Valve、 Bushing

Wolman Technology Zhangjiagang Co., Ltd.:
Established in 2018, it currently has 150
employees, including 1 master's degree
holder, 20 with bachelor's degrees, and 45
with college degrees.

The company is located in Jinfeng Town,
Zhangjiagang City, Jiangsu Province, which
has convenient transportation and a
developed economy, and is two hours away
from both Shanghai and Nanjing. It occupies
a total area of over 5,000 square meters,
with an existing building area exceeding
2,000 square meters.

The company specializes in the
manufacturing and sales of medical parts,
automotive components and accessories,
aerospace equipment and accessories,
metallurgical special equipment, molds, and
metal products. The company's factory
layout is reasonable, with advanced
technology and equipment, and
standardized management.



展商名录 (按公司名称字母排序)

Exhibitors List by Alphabetical Order

EH102 - A06

WUXI FORLAND TECHNOLOGY CO.,LTD.

Forland

More green more power

Add:Shanshui City Science & Industrial Park,
Binhu District, Wuxi, China

Email:wwy@forlandholding.com

Web:www.forlandholding.com

Tel:+86-510-85958898

Fax:+86-510-85958808



Main Product:automatic cold/hot sand core shooting machines, gravity die casting machines, low pressure casting machines and related robot integration, non-standard fixtures



Wuxi Forland Technology Co., Ltd. was founded in 2010. We are committed to the research and development, production, and sales of high-end intelligent automatic equipment & production lines in Foundry field. We are Jiangsu high-tech enterprise and the member of China Foundry Association. Our products are exported to Mexico and Europe and other places.

Our main products include hot core/cold core/inorganic core shooting production lines, gravity die casting production lines, low pressure die casting production lines and related post process production lines.



EH102 - A12

**Wuxi Fumao Environmental Protection
Technology Co., Ltd.**



Add:206 Chengnan Road, Xinwu District,
Wuxi City, China

Tel:086-0510-85222212

Web:www.jsfmhb.cn

Email:109716986@qq.com



Main Product:Environmental Protection
Equipment



Wuxi Fumao Environmental Protection Co.,
Ltd. is located in Wuxi, China. Focusing on
the research and development, production,
and sales of environmental protection
equipment, as well as epoxy flooring, FRP
anti-corrosion engineering, and installation
projects., Our products are exported to
many countries and regions around the
world, always adhering to the business
philosophy of "quality, innovation, service,
safety and health together". We provide
customers with integrated technology and
high-quality services in both domestic and
international markets.



展商名录 (按公司名称字母排序)

Exhibitors List by Alphabetical Order

EH102 - B35

**WUXI YOSHIOKA PRECISION TECHNOLOGY
CORP.,LTD.**

Add:No. 22 Dongchang Road, Xishan District,
Wuxi City, Jiangsu Province

Email:sales03@ysoka.com

Web:www.ysoka.com

Tel:+86-510-85221597-8002

Fax:86-510-85224627

Main Product:aluminum alloy, zinc-Alloy
die-casting parts

Yoshioka Founded in 2002, the company is an enterprise based on the professional diecasting industry, with 107 patents. Company in aluminum alloy, zinc-Alloy die-casting industry for many years, has accumulated rich experience in the development of cleaning, electrical parts, auto parts, electronic and electrical parts, office, equipment parts, textile parts, other parts with a strong R & D and design capabilities.

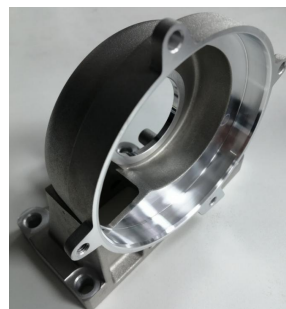

EH102 - C46

**WUXI JIN ZHAOYANG FOUNDRY
MACHINERY CO.,LTD.**

Add:No. 107, Xinyou North Road, Xinwu
District, Wuxi City, Jiangsu Province

Email:zyfm2000@163.com

Web:www.zyfm2001.com

Tel:+86-510-81027793

Fax:+86-510-81027793



Main Product:mechanical equipment

The company is located in the beautiful taihu Lake shore - Wuxi. The company specializes in resin sand technology, sodium silicate sand technology, iron mold sand covering technology, clay sand technology, coated sand technology and other complete sets of equipment and services, the company has advanced technology, is the industry recognized brand products.

展商名录 (按公司名称字母排序)

Exhibitors List by Alphabetical Order

EH102 - C01

Wuxi Mingteng mold Technology Co., Ltd.



Tel:0510-83318500

Email:wxmt@wxmtmj.cn

Add: Zhigong Bridge side, Lvhu
Village, Luoshe Town, Wuxi City

Tel:+86-15006183225

Email:wxmt@wxmtmj.cn

Web:www.wxmtmj.cn



Wuxi Mingteng Mould Technology Co., Ltd. was established in 2015, with more than 100 employees, including 15 designers. In recent years, we have continuously introduced talents, experienced casting technicians and mold designers and various experts such as casting mold, low pressure casting mold, high pressure casting mold and gravity casting mold.

The company has always pursued development by scientific and technological innovation, and is a high-tech enterprise in Jiangsu Province. At present, there are 2 authorized invention patents and 17 authorized utility models.

The main business is complex and difficult automobile casting mold, gravity casting mold, low pressure/high pressure casting mold, casting product processing (black and non-ferrous alloy) turnkey engineering, products and molds are widely used in automobile, construction machinery, new energy and other industries.



EH102 - A02
WUHU LONGXING ALLOY CO., LTD.

Add:1 No.Hexing Road, Sanshan
Development District, Wuhu, Anhui, PRC
Email:long@longalloy.com
Web:www.longalloy.com
Tel:+86-13805533588

Main Product:Copper castings, zinc based
alloy castings, copper alloy pipes, rods,
plates

LONGALLOY (CHINA) CO.,LTD.being the member of
China Foundry Association and Anhui Foundry
Association, is the professional supplier of
self-lubricating bearings,copper bushings and Zinc
Alloy.

Longxing was established in May 30, 2005, and has
become one of the biggest manufacturers of
self-lubricating bearings centrifugal casting and
continuous casting copper bushings.

We are the leading enterprise of China
self-lubricating bearings machinery copper
bushings and one of the important matching
manufacturers of international machinery giants.

The main applications are: higher-end mining
machinery, engineering machinery, hydroelectric
power machinery, Auto,shipping, petroleum and
machine tools etc.

The main products are: self- lubricating bearing,
centrifugal casting copper bushing,copper nut,
continuous casting bronze bar, copper pipe, worm
wheel and worm, zinc base alloy.

Our products have exported to America Europe
South Korea Japan and Australia .



展商名录 (按公司名称字母排序)

Exhibitors List by Alphabetical Order

EH102 - B08

**WUYANGBC (TSINGDAO) INTELLIGENT
EQUIPMENT CO.,LTD.**



Add: Pingdu Grange Industrial Park, Qingdao
City, China

Email: 15153200001@163.com

Web: www.wuyangbc.com

Tel: +86-532-86381888



Main Product: Clay sand production line、
Resin sand production line、 Modified water
glass production line、 Thermal regeneration
line、 Chrome ore selection、 Ultra-low
emission dust collector、 and so on



WuyangBC is one of the leading manufacturers of foundry sand treatment in China. We have three subsidiaries: WuyangBC intelligent equipment, Qingdao BCTD, and Colairs Environmental. Since 20 years ago, We has provided quality products, engineering and services for more than 2000 foundry enterprises in China and worldwide!

We focus on four business: Sand treatment, Sand regeneration, Dust collectors, Foundry automation. Our strong technical team can also provide preliminary design and overall planning for new foundries.

In recent years, we continue to develop high-end foundry sand processing technology, and have made rich achievements in national aerospace, 3D printing, top large-scale green sand projects, such as supporting DISA, Sinto, Tokyu, HWS and etc, as well as thermal regeneration, coated sand system, chromite sand regeneration and etc!

WuyangBC – Your reliable partner of foundry sand treatment solution!

EH102

Hong Kong Foundry Association

Email:15989850319@163.com

Tel:+86-755-84691266

Web:www.foundry.org.hk



(1)To provide members a platform of comprehensive support, raising the level of technology and market intelligence so as to enhance productivity and competitiveness.

(2)To facilitate closer connection and business opportunities among members.

(3)To establish inseparable relationship between peer associations and bodies both in China and Hong Kong. (4)To explore opportunities of linkage and develop co-operation with peer associations overseas.

展商名录 (按公司名称字母排序)

Exhibitors List by Alphabetical Order

EH102 - C18

**XIANGYANG JULI HIGH TECHNOLOGY
MATERIAL CO.,LTD**

Add:Shihua

Town,Gucheng

County,Hubei ,China

Email:xiangyangjuli@xyjllc.com

Web:www.xyjllc.com

Tel:+86-710-7611396

Fax:+86-710-7611597

Main Product:Refractory Material, Foundry
Coating

Xiangyang Juli High Technology Material Co., Ltd, established in 1973, has grown into a global and leading manufacturer of monolithic refractory and foundry coating with two plants in Xiangyang city covered more than 100,000 m². We dedicate to Foundry, Metallurgy and Non-ferrous Metal Industry with commitment of superior service and consistent quality. Our company was ISO9001:2000 certified in 2003 and awarded the authorized honor"Enterprise Credit Evaluation AAA" by China Foundry Association in 2015.We abide by the philosophy "Honesty and innovation", quality and customer satisfaction will always be our first priority, we do wish to build up long term friendship with our customers globally.



EH102 - A25
YIZUMI HOLDINGS CO., LTD.

Add:No.22 Ke Yuan 3rd Road, Shunde,
Foshan, Guangdong 528300, China
Email:lizhiqing@yizumi.com
Web:www.yizumi.com
Tel:+86-13760912126
Fax:+86-757-29262175-806

Main Product:Die-casting Machine

Yizumi Holdings Co., Ltd. (YIZUMI) was founded in Guangdong, China in 2002. It has spread its wings all over the world. As a benchmark in the field of molding equipment, it establishes several business divisions covering injection molding machines, die casting machines, rubber injection molding machines, high-speed packaging systems, and robotic automation systems, etc. It offers one-stop solutions as an equipment supplier, integrating the functions of design, research and development, manufacturing, sales and service, achieving diversified development.

YIZUMI



展商名录 (按公司名称字母排序)

Exhibitors List by Alphabetical Order

EH102 - A17

**INDONESIAN FOUNDRY INDUSTRIES
ASSOCIATION (APLINDO)**

Add: Apartemen Taman Semanan Indah, 2nd
Floor Unit 3. Jl. Taman Semanan Raya, Duri
Kosambi, Cengkareng, Jakarta 11750

Tel: +6287815648881

Email: iwanlukito@trieka.co.id,

aplindo71@gmail.com

Web: aplindo.web.id



Main Product: Banner & Brochure APLINDO

INDONESIAN FOUNDRY INDUSTRIES ASSOCIATION (APLINDO) established on December 9, 1981 is an organization that is used as a tool of struggle to create a healthy industrial climate in Indonesia, striving for industry to grow and develop towards a self-reliant industry that is strong and efficient so that its products can compete strongly in the global market.

EH102 - A29

The Institute of Indian Foundrymen

展商名录 (按公司名称字母排序)

Exhibitors List by Alphabetical Order

EH102 - B06

**YONGHONG BAODING FOUNDRY
MACHINERY CO . , LTD**

Add:West of Fangshang Village,Mancheng District,Baoding City,Hebei Province,China.

Email:jiachenhao@yonghongbq.com

Web:www.yonghongbq.com

Tel:+86-312-7027666

Main Product:Vertical Molding Machine and Auxiliary Equipment(AMC); Horizontal Molding Machine; Bottom Pouring Machine;Tilting Ladle Type Pouring Machine; Post Treatment Equipment; W Type Separation Vibrating Conveyor; Strong Rotor Sand Mixing Machine; Sand Treatment Equipment; De-dusting Equipment; Wear-resisting pieces;Automobile parts;Spareparts of molding machine. Foundry sand Grooved pipes and fittings;

Yonghong Baoding Foundry Machinery Co.,Ltd is a collection of scientific research, production, management, export in one of the private enterprises. The existing staff of 900 ,In amount of them there are 173 professional and technical staff.

At present, Yonghong Baoding Foundry Machinery Co.,Ltd have obtained 11 product invention patents, 25 utility models and 9 software Copyrights. All products adopt CAD assisted design, 3D modeling and simulation analysis of key components, aiming at the actual problems of the industry, to solve the bottleneck problems and industrialization obstacles such as automation of casting equipment and Internet, to be improved the level of industry technology and application.

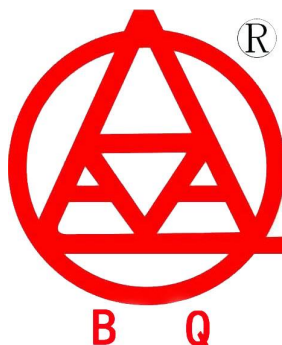

EH102 - A07
YUNNAN TAIBIAO PRECISION CASTING
CO.LTD



Add:CNC Industrial Park, Research and Industrial Park, Hongta District, Yuxi City, Yunnan Province.

Email:tb045759@163.com

Web:<https://taibiao.foundry.cn>

Tel:+86-877-6560208

Fax:+86-877-6560208



Main Product:Machine tool castings

Yunnan Taibiao Precision Casting Company specializes in the manufacturing of high-end CNC machine tool castings. The company is equipped with a range of advanced technologies, including resin sand, clay sand, vanishing mould, 3D printing and other moulding lines, over 500 sets of CNC machining centres, physical and chemical laboratories, a constant-temperature precision workshop and more. This enables the company to produce and process a wide range of products, including large (heavy) precision CNC machine tool castings, with a weight of up to 50T. The company is capable of processing 110,000 tonnes of large (heavy) precision CNC machine tool castings, with a single piece weighing up to 50T. The products are mainly for vertical, plus, horizontal, gantry, lathe, boring and milling machines and other high-precision, high-stability functional kits. The products are mainly high-precision and high-stability functional kits for vertical, horizontal, gantry, lathe, boring and milling machines.

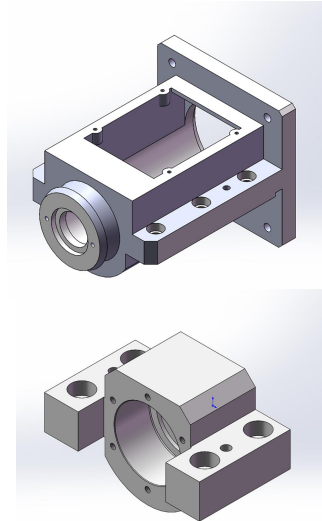

展商名录 (按公司名称字母排序)

Exhibitors List by Alphabetical Order

EH102 - B32

**ZHEJIANG XINYOU ENVIRONMENTAL
PROTECTION TECHNOLOGY CO., LTD.**

Add: Quzhou Changshan County Xindu
District industrial zone

Email: liuzhiqinglled@qq.com

Tel: 15658565558

Main Product: Air pollution environmental
protection dust removal equipment

The company's main products for air pollution treatment series: dust treatment, organic waste gas treatment. Specializing in the production of dust collectors, waste gas treatment equipment, for the ore furnace, medium-frequency furnace, electric arc furnace, Refining Furnace, converter and other supporting pollution treatment and purification equipment. It is mainly used for dust treatment, waste gas treatment, flue gas desulphurization, purification, pneumatic conveying and material recovery in steel making, foundry, metal smelting, ore smelting and other industries. The company has professional design and technical personnel, skilled engineering installation team, mature production technology, can undertake a variety of environmental engineering design and installation and technical advice.



鑫友·环保

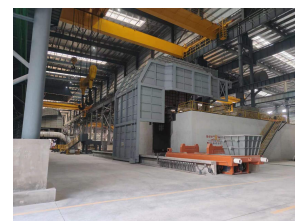

EH102 - A13
SINO PEAK TECHNOLOGY DEVELOPMENT
CO.,LTD



Add:Unit West 8C,Teda Financial Street Bin Hai District TianJin China

Email:sino@zhongfugroup.link

Tel:+86-13920288045 ;+86-22-59810596



Main Product:Carbon additives, Ceramisite, Founrdry coke, Steel scrap

Sinopeak is a producing and sales enterprise dedicated to the development and marketing of carbon, metallurgical casting materials and other products for domestic and international markets.

Our main products include calcined petroleum coke, graphitic petroleum coke, asphalt coke, casting coke, metallurgical coke, and ceramisite.

The product is widely used in the fields of new energy, metallurgy and casting, not only selling well in the domestic market, but also exported to Japan, South Korea, Thailand, the Middle East and Europe, and has been unanimously recognized and praised by domestic and foreign customers.

Sinopeak adheres to the principle of "Morality first and honesty priority", continuously providing customers with thoughtful and meticulous personalized services, and offering stable and reliable products to achieve mutual cooperation and win-win results.



展商名录 (按公司名称字母排序)

Exhibitors List by Alphabetical Order

EH102 - C30

**CONFEDERATION OF CHINESE
METALFORMING INDUSTRY**



中国 锻 压 协 会
Confederation of Chinese Metalforming Industry

Add:10 /F, Boya Tower C, Zhongguancun Life
Science Park, Beiqing Rd.,Changping Beijing

Email:exhibition@chinaforge.org.cn

Web:www.chinaforge.org.cn

Tel:+86-10-53056669

Fax:+86-10-53056644

Main Product:Furnace, Software,
Intelligence, Standards, Information
service, Magazines

CCMI is an organization serving forging, stamping and sheetmetal industry.On July 19, the MetalForm China Exhibition will be held at the NECC in Shanghai, covering the whole industry chain of forging, stamping and sheet metal. In addition, Fukin Technologies Services (Beijing) which set up by CCMI, is mainly engaged in the research, development, design, production, installation and engineering contracting of industrial furnaces, combustion systems and heat exchange equipment, as well as forging, stamping, sheet metal production industry process software agent sales, secondary development, etc..

EH102 - C30
CHINA WELDING ASSOCIATION

Add:2077Chuangxin Road , Songbei
District,Harbin,150028,China
Email:china_welding@yeah.net
Web:<http://www.china-weldnet.com/>
Tel:+86-451—86333949
Fax:+86-451—86333949



Main Product:Welding Industry Association

China Welding Association was founded in 1987. It is a national first-level industry organization composed of enterprises with welding as the leading process specializing in welding materials; welding equipment; cutting; complete sets of equipment and special equipment production and other welding-related enterprises; institutions and social groups with legal person status, such as enterprises, scientific research institutes, colleges and universities, training institutions and business departments. CWA has more than 1,300 members now. The secretariat of China Welding Association is a permanent organization with 17 branches, two representative offices and two wholly-owned and holding companies.

展商名录 (按公司名称字母排序)

Exhibitors List by Alphabetical Order

EH102 - C30

CHINA HEAT TREATMENT ASSOCIATION

Add:Room 518, Science and Technology Building, No.12 Shouti South Road, Haidian District, Beijing

Email:chta@chta.org.cn

Web:<http://www.chta.org.cn/>

Tel:+86-10-64937312

Fax:+86-10-62924532

Main Product:Services

The China Heat Treatment Association (Chta) is based on the former China Heat Treatment Association (founded in July 1986) , established in August 1991 with the approval of the Ministry of Civil Affairs of the State Council, is the national heat treatment industry-related production, scientific research, design, institutions and other relevant organizations and voluntary formation of the national, industrial, non-profit industry organizations at the national level (corporate)



EH102- C30
CHINA FOUNDRY ASSOCIATION

Add:14th Floor, China Academy Of Science & Technology Building, No.2 Shouti South Road, Haidian District, 100044, Beijing, China

Email:expo@foundry.com.cn

Web:https://foundry.org.cn/

Tel:010-68418899

Fax:010-68458356

Main Product:0

China Foundry Association founded in 1986, China Foundry Association (CFA) is comprised of foundry enterprises, local foundry associations, foundry related enterprises, technical and research institutes, colleges and universities voluntarily. It is a national first-class organization in the foundry industry registered by the Ministry of Civil Affairs, and it is affiliated to SASAC (State-owned Assets Supervision and Administration Commission) of the State Council of P. R. China. China Foundry Association is the chairman unit of the Presidium of China Federation of Industrial Economics, the vice-chairman unit of China Machinery Industry Federation, the vice-chairman unit of China Association for Machinery Standardization, the vice-chairman unit of China Social Organization Standardization Alliance/China Society Standardization Alliance, the vice-chairman unit of National Intelligent Foundry Industry Innovation Center, and the vice-chairman unit of China Industrial Photography Association. China Foundry Ass.

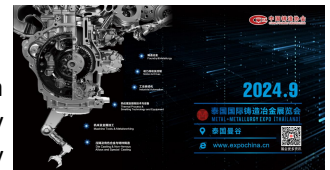
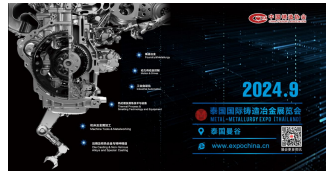
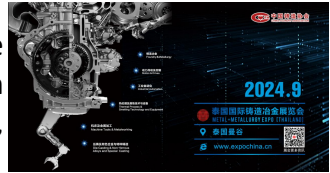

展商名录 (按公司名称字母排序)

Exhibitors List by Alphabetical Order

EH102 - A42

**CHONGQING JINGJIANG AUTOMOBILE
AXLE SHAFT CO.,LTD**

Add:3#, Jinfu Rd, Industry Park, Gunan Street, Qijiang District, Chongqing City, China

Email:cqjjbz@cqjjbz.cn

Web:www.cqjjbz.cn

Tel:0086-18250157531

Main Product:Heavy and medium-sized automobile shaft; Light vehicle shaft; Mini, pickup truck shaft; All kinds of through shaft hollow shaft, shafts to export and auto parts.

Chongqing Jingjiang Automobile Axle Shaft Co., Ltd. is a company focusing on the development of automobile axle products, with an annual output of 2 million shaft products. And to provide quality products and services for global automotive OEM manufacturers. At present, it has established good partnership with well-known domestic and foreign manufacturers such as Daimler-Benz, FAW Toyota, Dana, Dongfeng, Qingling, Great Wall, BYD, SAIC Maxus, Hande Axle, Sinotruk , Dana Axle, Fangsheng Axle and so on.



罗英杰

重庆荆江汽车半轴股份...



吕思年

重庆荆江汽车半轴股份有限公司



扫描二维码, 添加我的企业微信

企业微信

EH102 - C04

Zibo Tongpu Vacuum Equipment Co., Ltd.

TOVAC®

Add:No. 41 Kaitai Avenue, Gaoqing
Economic Development Zone, Shandong
Province

Tel:+86-533-2904092/2904091
13506439278

Fax:+86-533-2903438/8176869

Email:topvacuum@163.com

Web:www.topfoundry.com



Main Product:Lost foam, V method casting
equipment and various vacuum pumps



Zibo Tongpu Vacuum Equipment Co., Ltd. is located in China's machinery industry manufacturing base - Gaoqing Economic Development Zone, Zibo, Shandong. The company was established in 2000 and now covers an area of more than 14,000 square meters and a construction area of 8,000 square meters. There are technical centers, testing centers, foundry companies, machining workshops, riveting and welding workshops, and assembly workshops. It is a national high-tech enterprise integrating engineering design, equipment manufacturing, engineering installation, after-sales service, process service and personnel training. It specializes in the production of lost foam, V method and other casting equipment and various vacuum pump units in the industry. significant market share.