

第十七届中国国际压铸工业展览会 The 17th China International Die Casting Industry Exhibition

第十七届国际有色及特种铸造展览会 The 17th International Nonferrous and Special Casting Exhibition

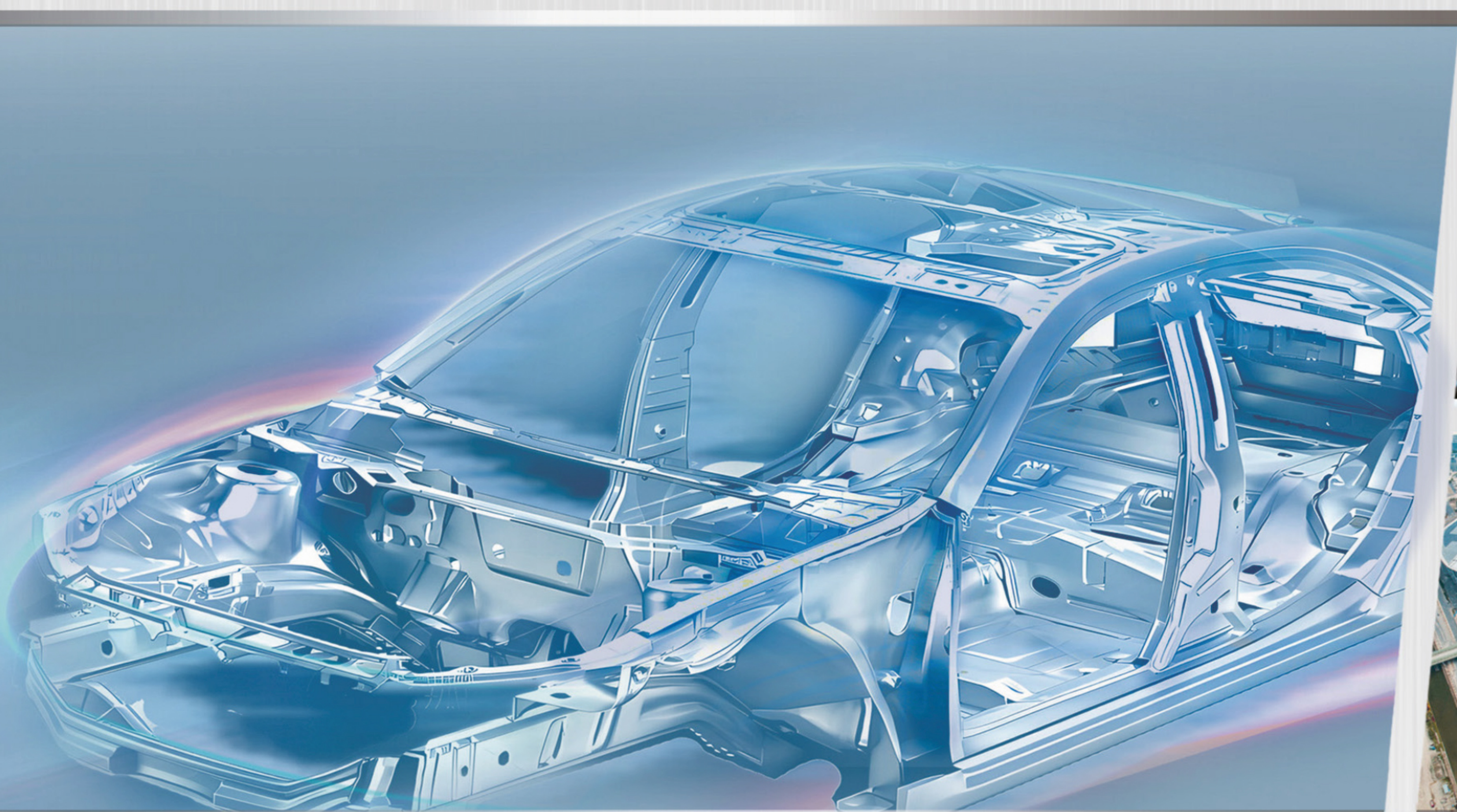

2024.7.4-7.7 | 国家会展中心(上海)
NECC, SHANGHAI

构建铸造产业链高质量发展新格局
Build a New Pattern for High-quality Development



全球领先的压铸行业盛会

THE WORLD LEADING DIECASTING EVENT

“双碳”目标引领 一体化轻量技术赋能

“中国国际压铸工业展览会”立足经典品牌展“国际有色及特种铸造展览会”，是由中国铸造协会携手苏州市压铸技术协会、香港铸造业总会合力打造的覆盖压铸及有色铸造全产业链的国际化展会。

以“双碳”目标为引领，随着新能源汽车的快速发展，一体化压铸已经迎来最好的时代，轻量化铸造已成为大势所趋。在此背景下，“第十七届中国国际压铸工业展览会”“第十七届国际有色及特种铸造展览会”与“第二十二届中国国际铸造博览会”同期举办，将汇聚海内外压铸及上下游杰出企业，全面展示压铸工艺、有色铸造及轻量化发展的新产品、新技术、新装备。展会聚焦前沿、关注热点、引领创新，旨在为高质量发展助力、为融入新时代赋能。

Empowering to Achieve Carbon Goal with Giga Diecasting and Lightweighting

Based on the classic exhibition "Nonferrous China", China International Die Casting Industry Exhibition (Diecasting China) is a brand exhibition jointly created by China Foundry Association, Suzhou Die Casting Technology Association and Hong Kong Foundry Association, covering the entire industrial chain of diecasting and lightweight technologies.

Guided by the carbon goal, and with the rapid development of new energy vehicles, giga die-casting has ushered in the best era, lightweight casting has become the trend. In this context, the 17th edition of Diecasting China will be held in concurrent with METAL CHINA 2024, bringing together outstanding domestic and overseas diecasting and its upstream and downstream enterprises, showcasing a comprehensive of new products, technologies, and equipment which represent the trends of diecasting and lightweight production. The exhibition focuses on the forefront tech and hot topics, and leads innovation, aiming to assist in building a new pattern of high-quality development, and empower to integrate into the new era.

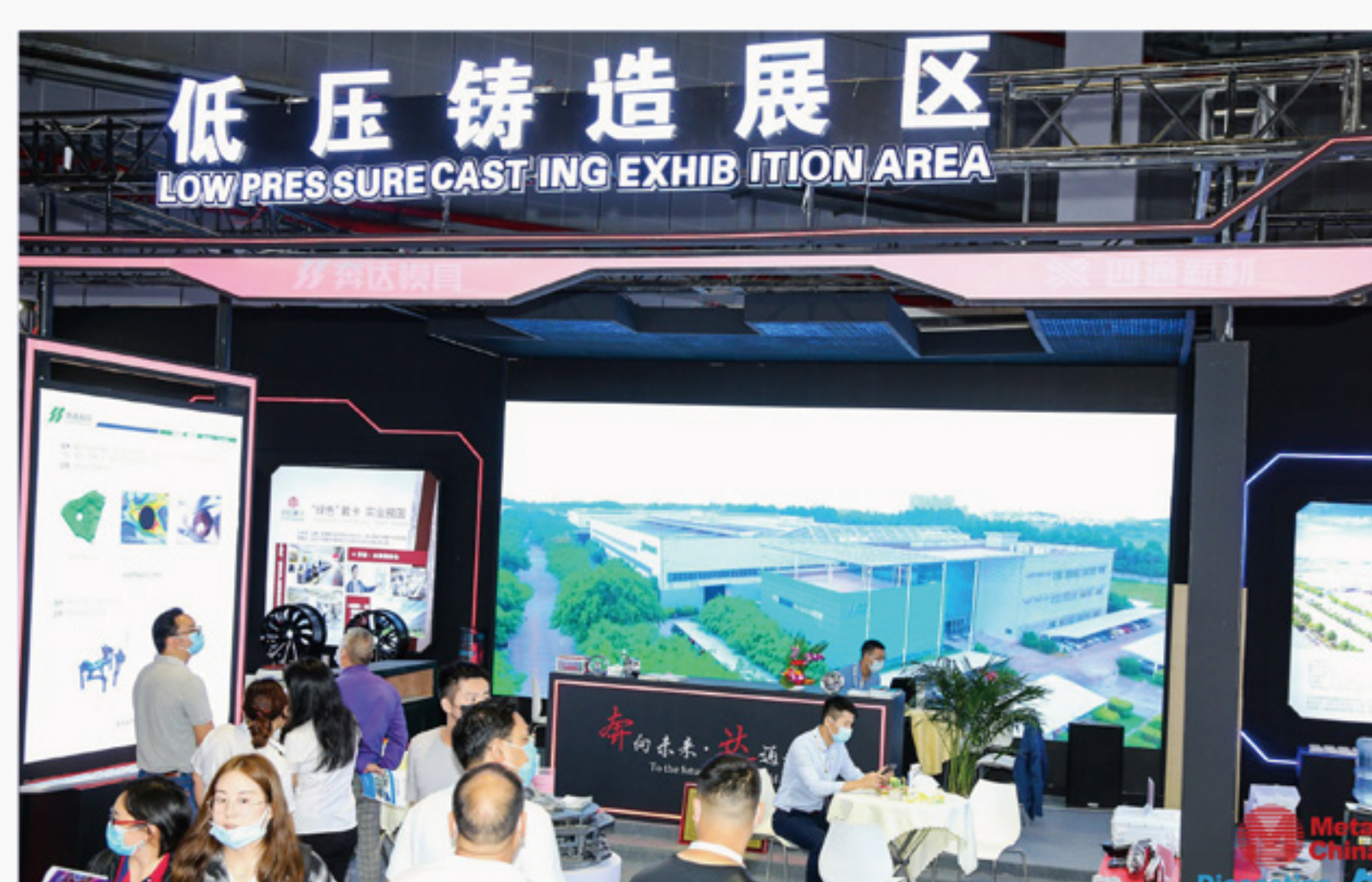
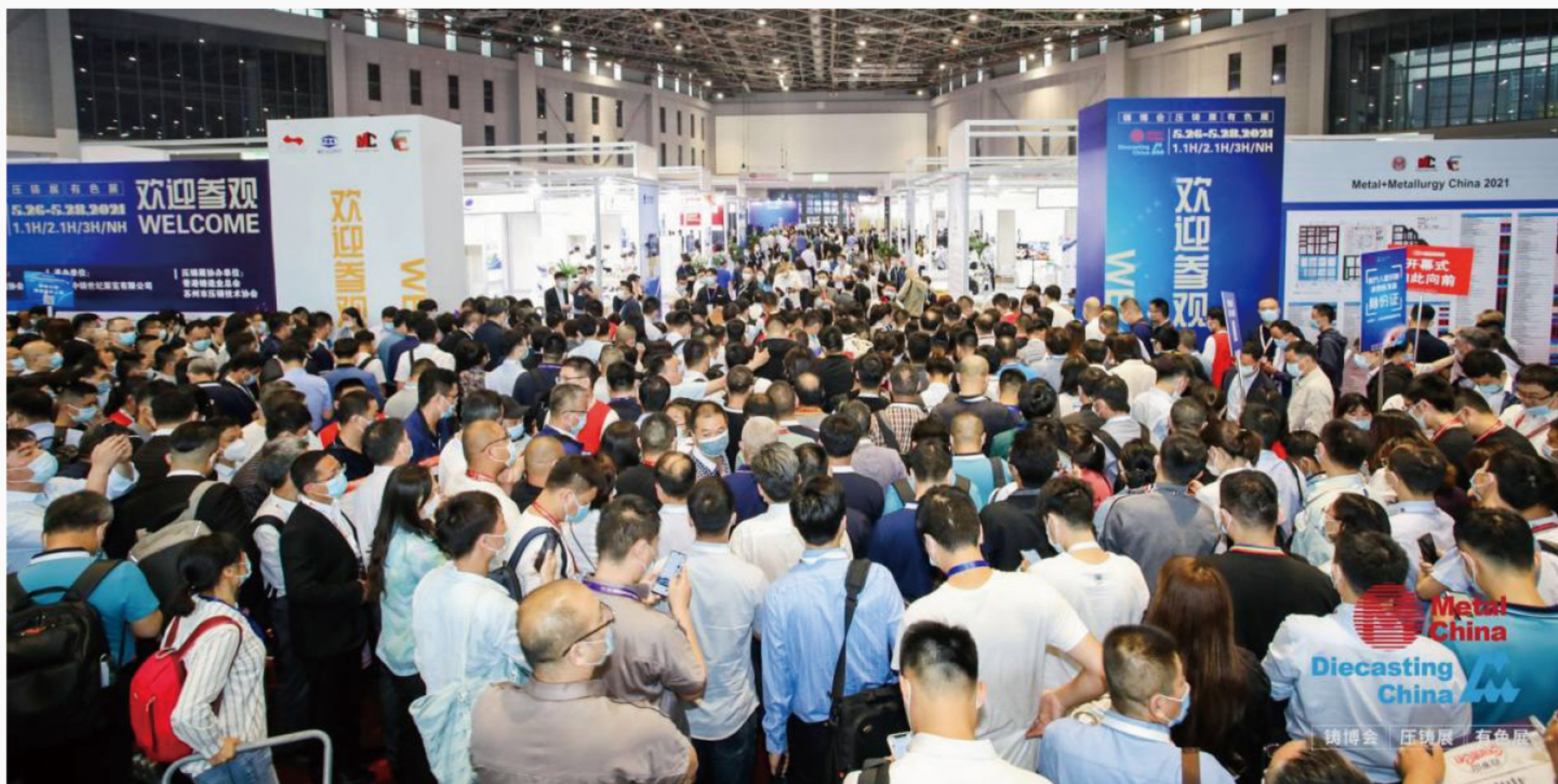

展商评价

EXHIBITORS EVALUATION

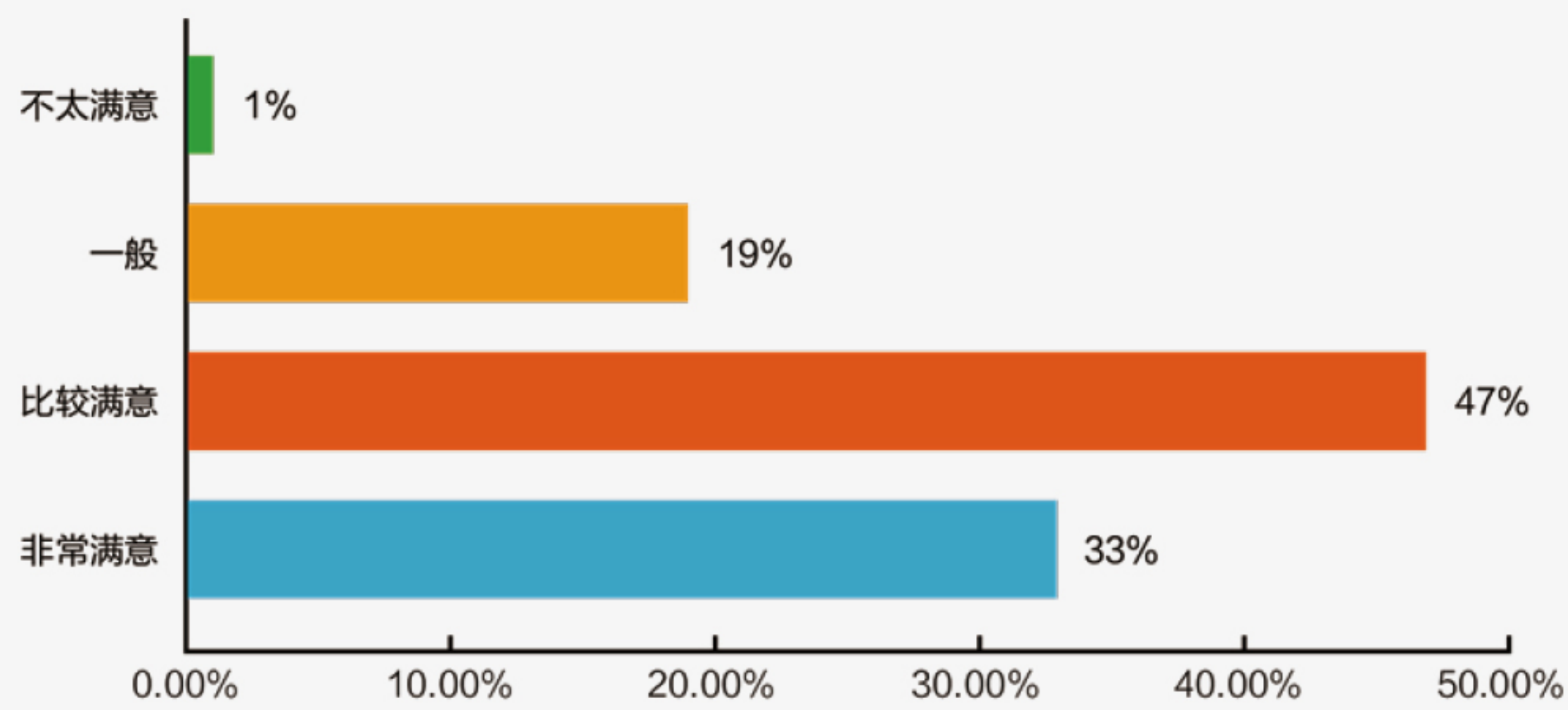

总体满意度 99%
Overall satisfactory: 99%

观众分析

VISITORS ANALYSIS

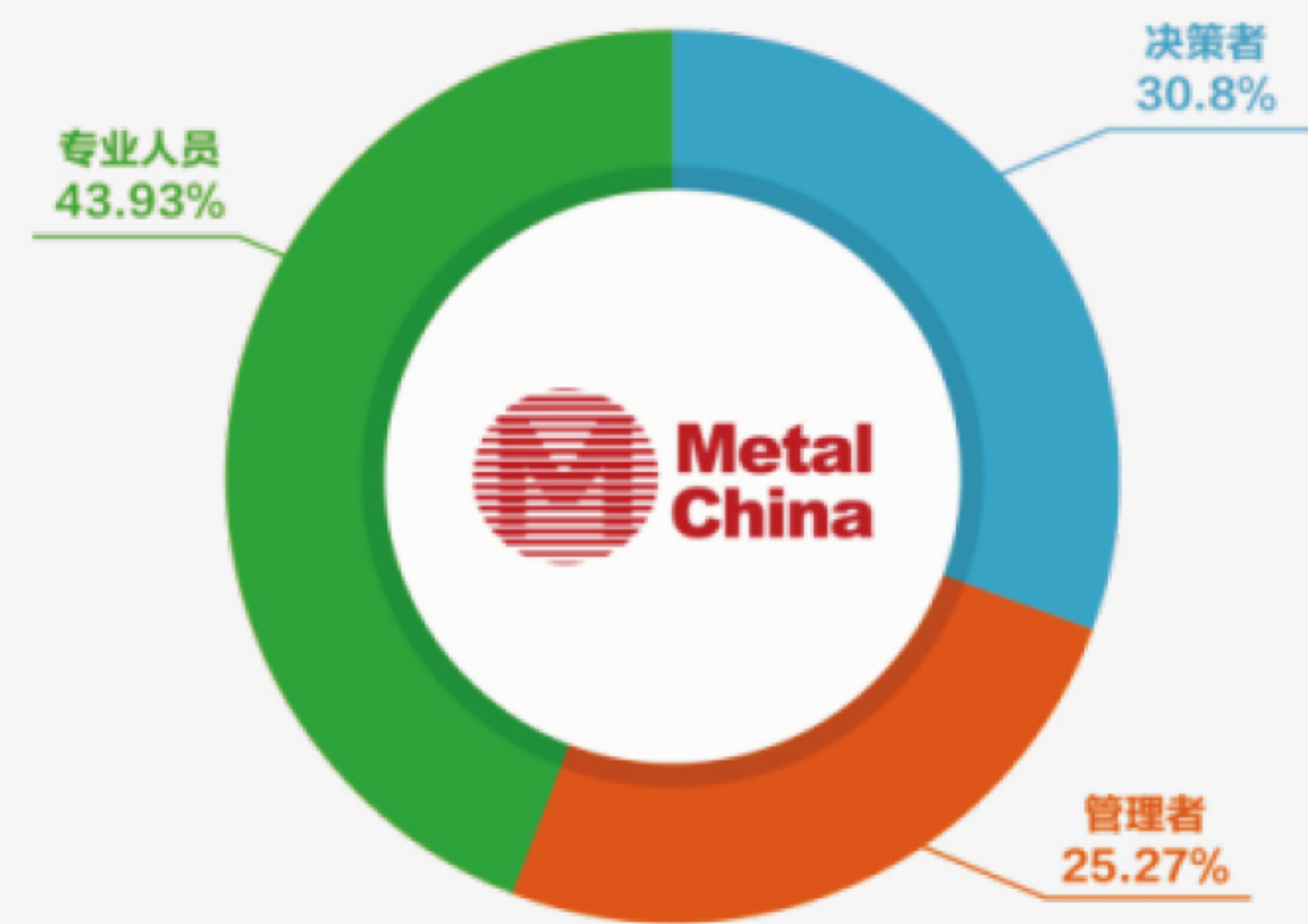

56% 为决策者或参与决策者
56% of the visitors are decision makers

观众地域分布

VISITORS GEOGRAPHICAL DISTRIBUTION

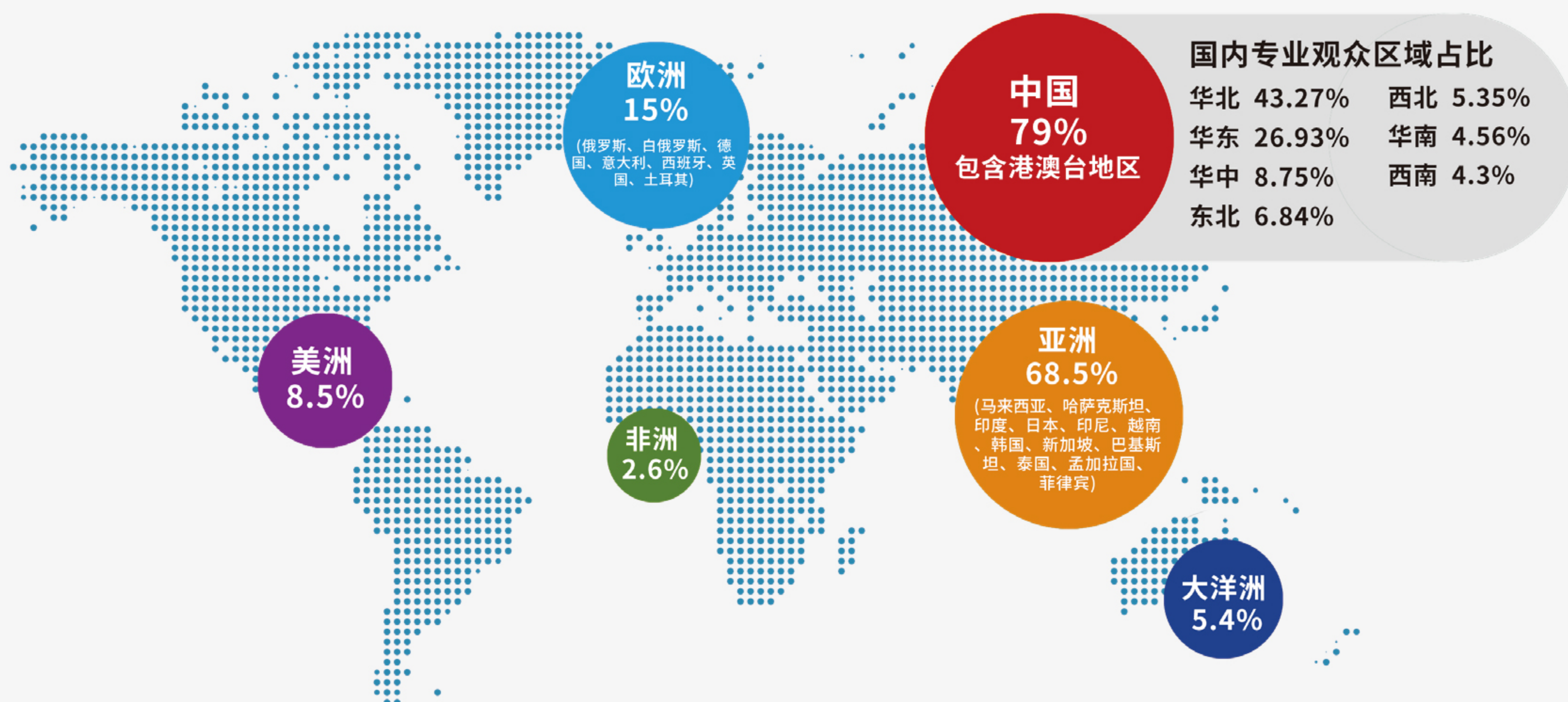

展会凸显国际化、海外观众占比 21%

The international level is improved, with overseas visitors account for 21%.

专业买家和观众行业

BUYERS AND VISITORS PROFILE

汽车零部件、通讯、航空航天、新能源、家电、医疗器械、仪器仪表等。

Auto parts, communication, aerospace, new energy, household electrical appliances, medical devices, instruments and meters, etc.

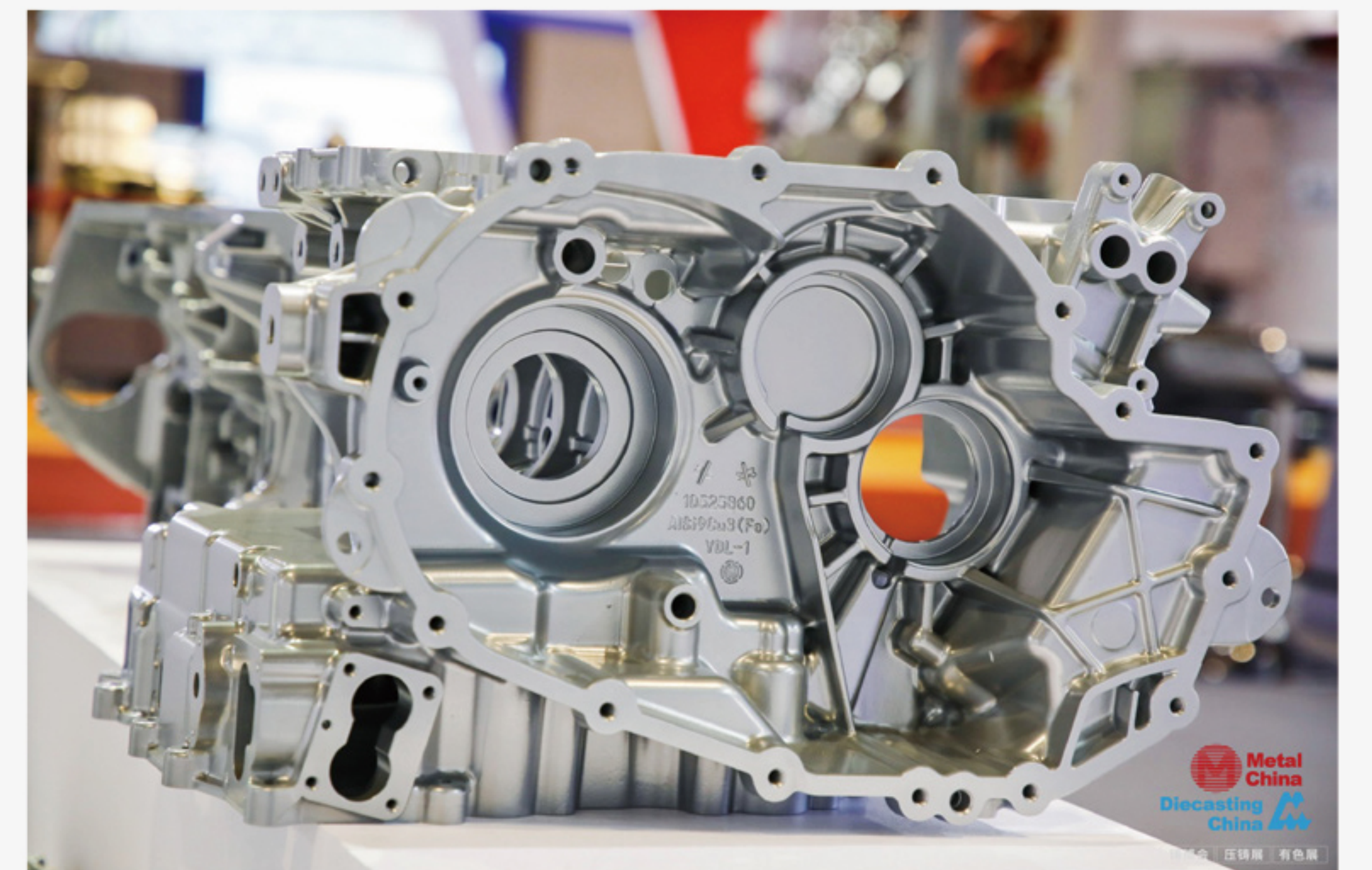
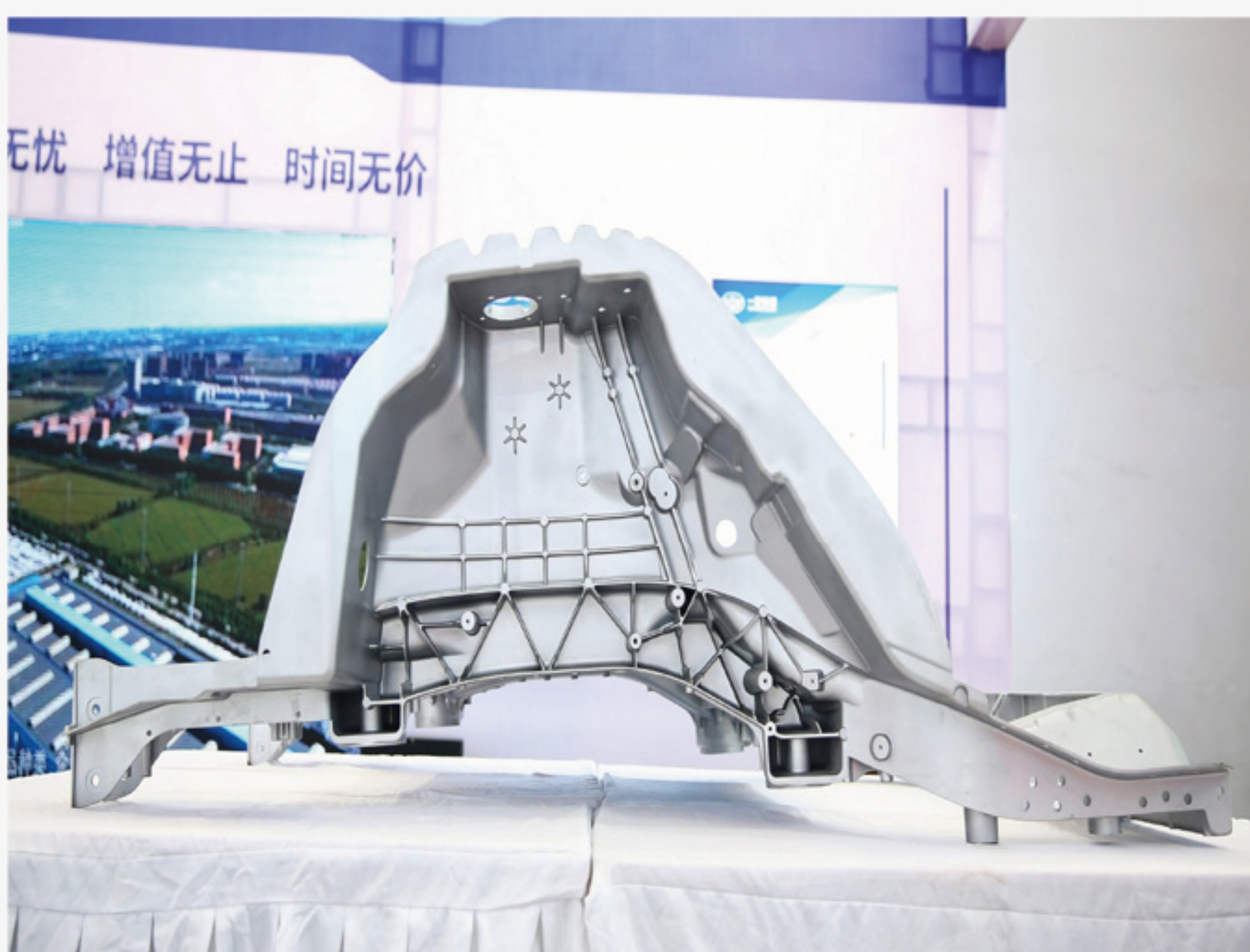

DIECASTING CHINA 2024

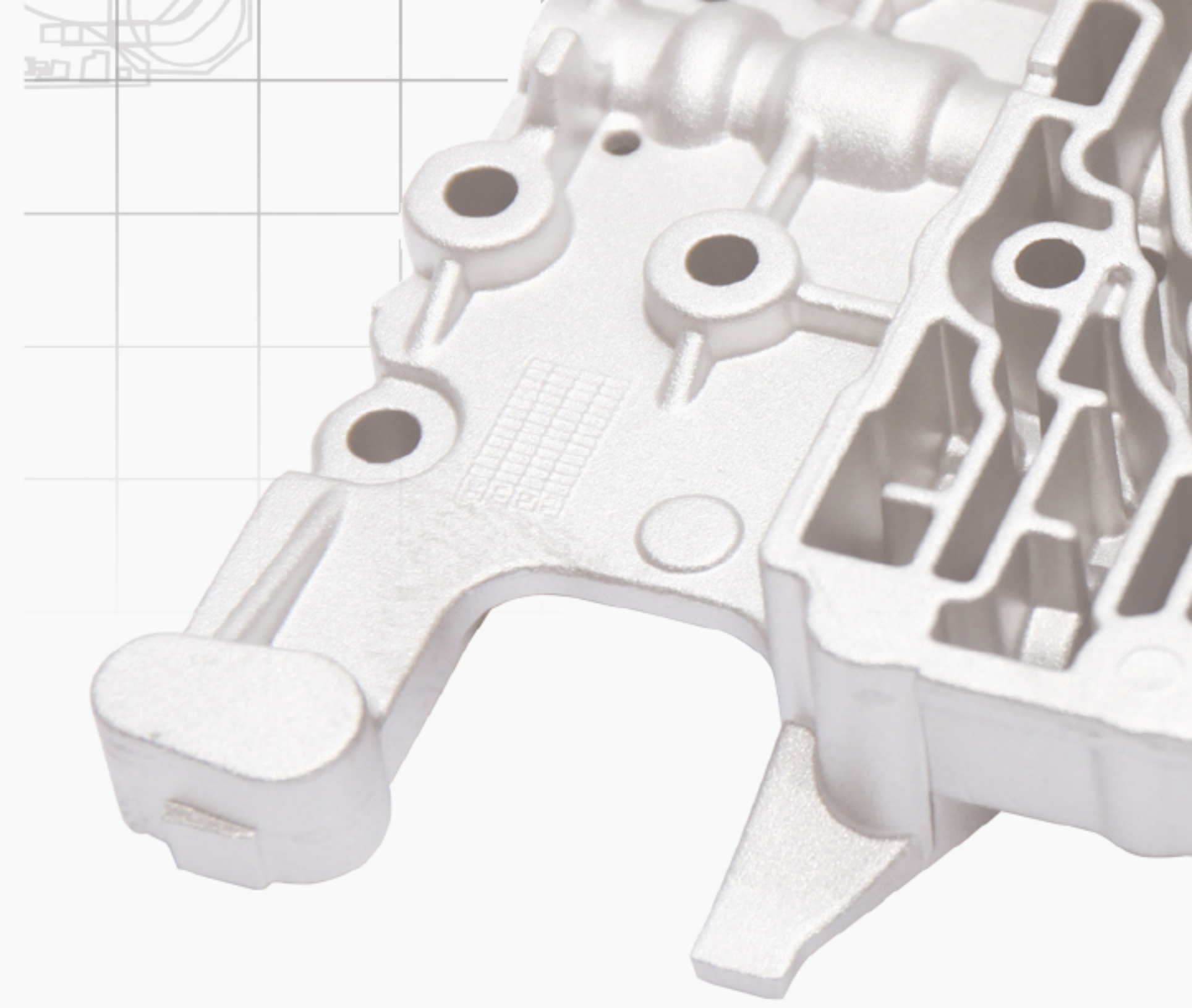

27,000m² 展示面积规模盛大
Large exhibition scale

300+ 头部企业领衔参展
Leading companies' participation

150+ 平行论坛聚焦热点
Concurrent events focusing on hot topics

150,000+ 专业观众共襄盛会
Visitors (METAL+DIECASTING)

细分展品范围、产业链全覆盖

SUBDIVIDED EXHIBITS SCOPE, FULL COVERAGE OF INDUSTRIAL CHAIN



不容错过的展会

AN EXHIBITION CAN'T MISS

- 行业发展的风向标、晴雨表
Industry's wind vane and barometer
- 企业品牌展示的最佳平台
A perfect brand display platform
- 企业市场拓展的最优途径
Most effective channel to expand market
- 实现国际朋友圈的新拓展
New expansion of international circle of friends



感受技术力量，聆听时代强音

LISTEN TO THE STRONG VOICE OF THE TIMES

- 一体化压铸技术研讨会
Seminar on giga diecasting technology
- 低压、挤压、半固态技术研讨会
Seminar on low-pressure, extrusion, semi-solid technology
- 轻量化铸件生产技术研讨会
Seminar on lightweight casting production technology
- 有色铸造安全环保研讨会
Seminar on safety and environmental protection
- 多场铸件采购洽谈会
Casting sourcing fairs
- 多场新产品发布会
New products releases
- 多场企业战略合作签约仪式
Enterprise strategic cooperation signing ceremonies
- 优质压铸件金奖评选活动
Gold award ceremony for diecastings

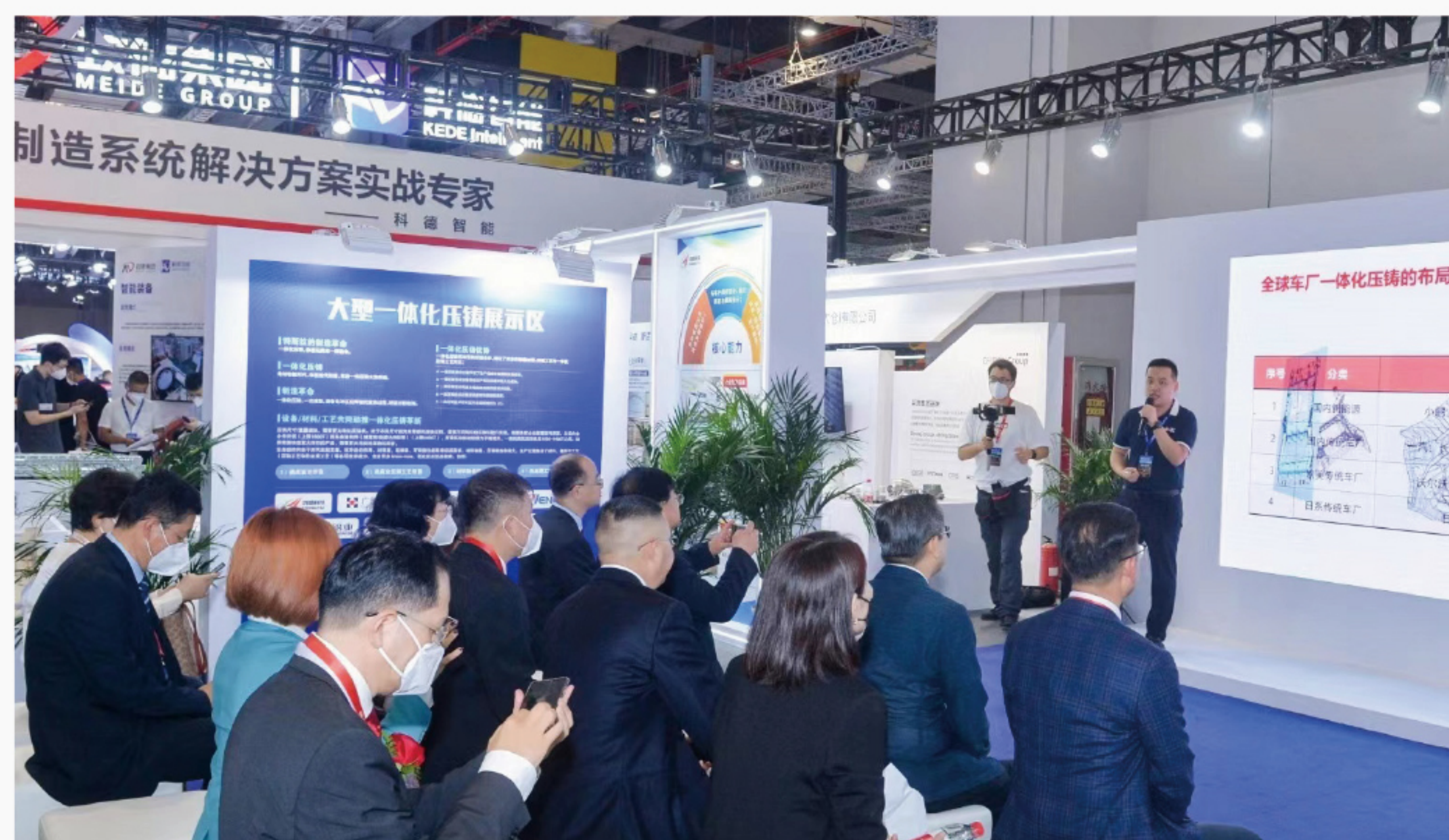

收费标准 Booth Rate

展位类型 Type	价格 Price		备注 Notes
	普通展区 General area	精品展区 Premium area	
标准展位 Standard Booth	RMB 12000/9m ²	RMB 2000/m ² (Min.12m ²)	主办方统一搭建 Built by the organizer
光地展位 Raw Space	RMB 1200/m ² (Min.36m ²)	RMB 1800/m ² (Min.24m ²)	展商自行搭建 Exhibitors build on their own

说明 Notes:

1. 双面开标准展位加收10%费用;
An extra charge of 10% will be required for double-side open standard booth.
2. 中国铸造协会会员单位享受展位费95折优惠。
Member companies of China Foundry Association shall enjoy a discount of 5% for the booth fee.

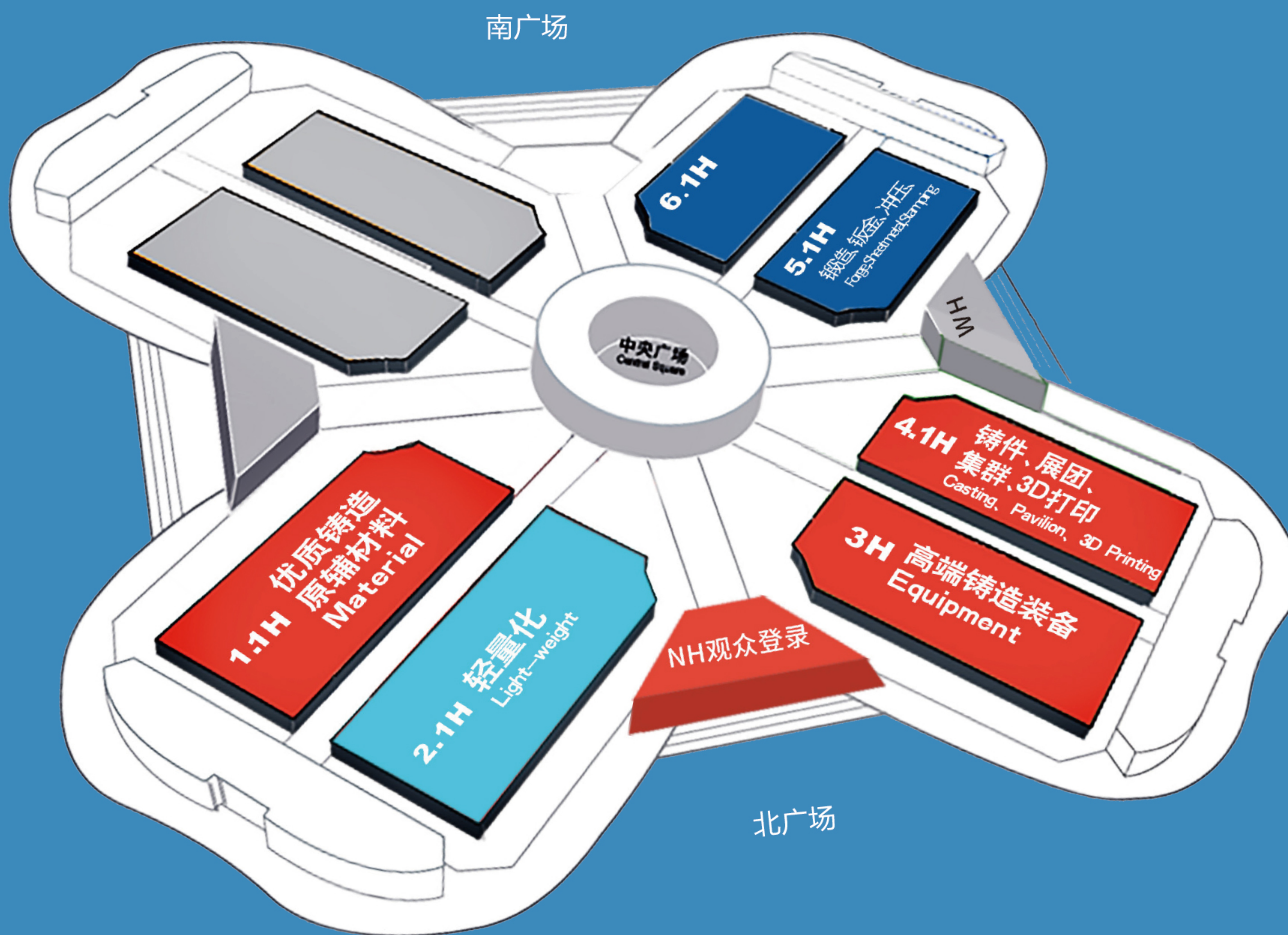

参展咨询

CONTACT

中国铸造协会
China Foundry Association

陈海阔 Chen Haikuo
13381183827 (同微信)
Email: chenhaikuo@foundry.com.cn

苏州市压铸技术协会展览部
Suzhou Die-Casting Technology Association

蒋浩洁 Jiang Haojie 18120070194
张山根 Zhang Shangen 18015595381
Email: jhj@diecasting-tech.com
zhangsg@diecasting-tech.com

香港铸造业总会展览部
Hong Kong Foundry Association

胡娟秀 Hu Juanxiu 15989850319/13322931691
王伟成 Wang Weicheng 13423965343
Email: hkdfachinaoffice@163.com
15989850319@163.com
yman13423965343@163.com